

ifi

iDSD

PHANTOM

User Manual

Thank you for purchasing this PHANTOM series iDSD. The **iDSD PHANTOM** is a flagship, reference-class streaming DAC/Amp system.

Step into a world where the boundaries between you and your music disappear, and you can finally hear it exactly as you would have recorded it.

A triumph of form and function, the iDSD PHANTOM unites a reference-class DAC, high-resolution network streamer, and powerful headphone amp in one – a trinity of iFi innovation and development, brought together in one incomparable experience.

Behind its build lies an unrivalled specification, carefully tailored for studio-grade sonic command. DSD Remastering up to DSD2048 and K2HD Technology offer a level of control unattainable outside the world's finest recording studios, while XSpace Pro Pro, XBass Pro, seven digital filters and real-time tube and solid-state mode switching allow each listener to tailor the experience perfectly for each song, setup, or setting.

Bring the studio home and become more than just a listener. Experience the iDSD PHANTOM, and vanish into the music.

FEATURES

- Reference-class DAC/preamp, network streamer and headphone amplifier
- Remarkable power – up to 4,676mW RMS & 7,747mW Max to drive the toughest headphone loads with ease
- Ultra-res PCM 768kHz and DSD512 streaming over Wi-Fi or Ethernet
- Quad-stack DAC – 4x DACs in interleaved configuration enables exceptional resolution
- DSD Remastering: option to up convert PCM and DSD files to DSD1024 or DSD2048
- 7 selectable digital filters including JVCCKENWOOD' s K2HD Technology
- Two discrete input stages – switch between solid state and NOS GE5670 vacuum tubes in real-time
- Intelligent app control – works with iFi Nexis for remote control and OTA updates
- Three power modes: Normal for IEMs, Turbo for mid-sensitivity headphones, and Nitro for demanding headphones with a 18.4V max output
- Exemplary build quality, comprehensive connectivity, and informative colour display

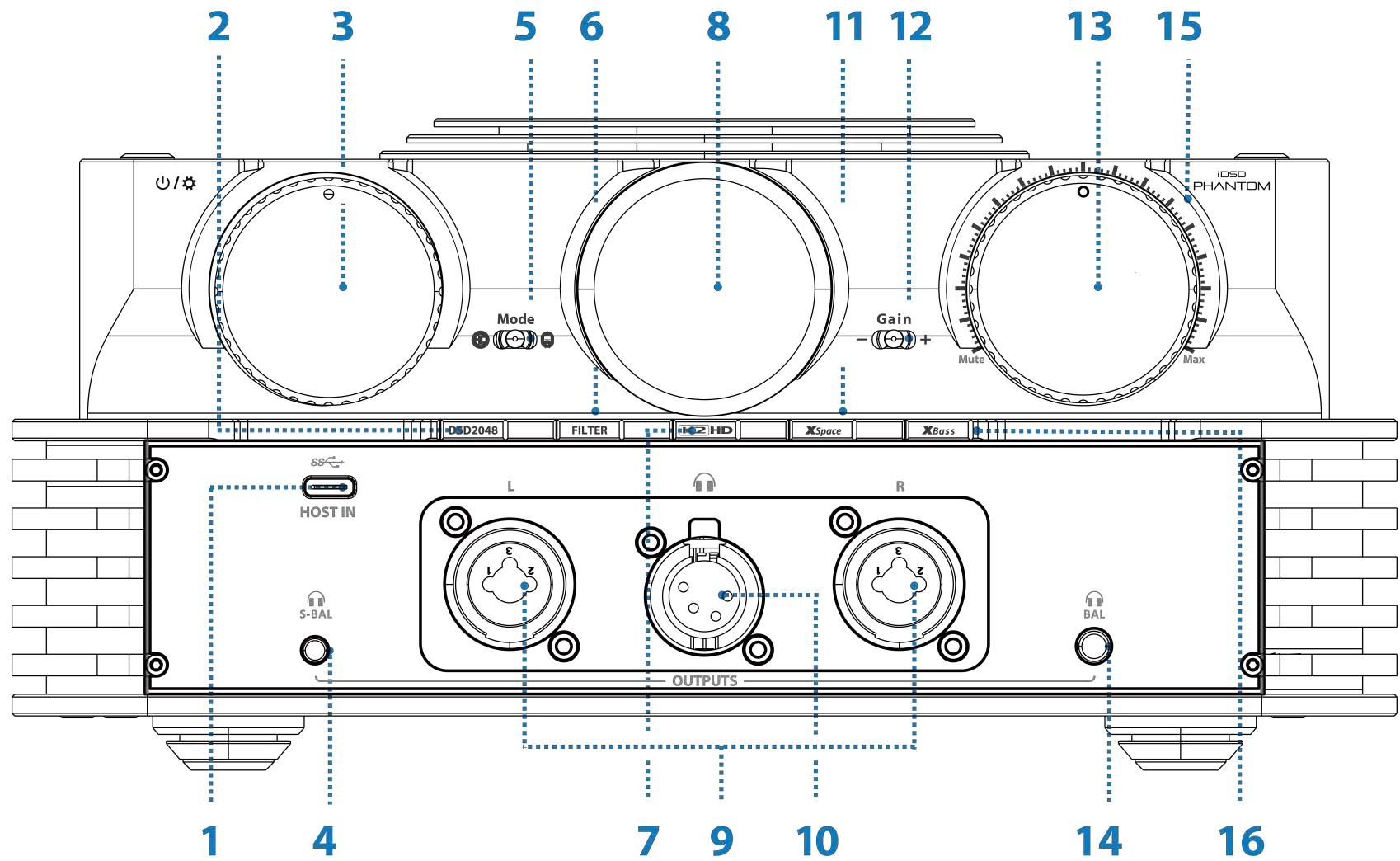

1. USB-C Host Input

The standard USB-C host input port can be connected to external USB storage devices such as external HDDs, USB flash drives, etc. USB 2.0 and USB 3.2 are supported.

2. DSD Remastering Mode Selection and Exit Settings Menu

DSD Remastering

Short press the button to select between the four available DSD Remastering modes. The default setting is **Disabled**.

DSD Remastering can also be enabled through the menu:



When enabled, incoming audio (excluding DSD512) is converted to either DSD512, DSD1024, or DSD2048, based on the listener's selection, along with their chosen digital filter. This includes the Bit-Perfect filter (which, by definition, applies no digital filtering).

Please note that any active digital processing options are applied to all digital input sources, including USB, LAN, and S/PDIF (Coaxial/Optical) inputs.

S/PDIF digital inputs are limited to maximum sample rates of 192kHz PCM and DSD64 via DoP.

We encourage listeners to experiment with all the available options to find their optimal listening experience.

Exit Settings Menu

Short press the button while in the menu interface to return to the previous menu level or exit the settings menu and return to the home screen.

3. Multi-Function Dial

Controls:

- Power On/Off
- Mute/Unmute
- Settings Menu

Power On/Off

Short press the dial for 1s to switch on, long press the dial for 3s to switch off.

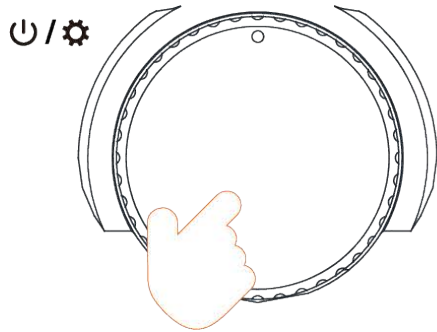

Short press



Power ON

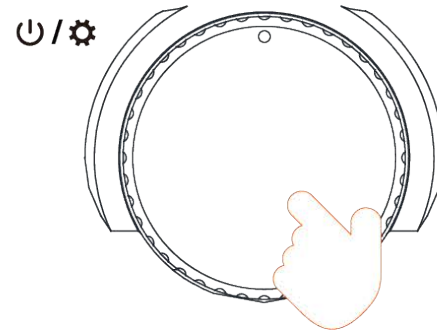

Long press



Power OFF

Mute/Unmute

Short press the dial to mute/unmute. A mute icon will appear next to the volume level to indicate that the mute function is active:



Mute



Unmute

Tip: Mute mode cannot be cancelled by turning the volume control dial - after a short press to mute, mute mode can only be cancelled by short pressing the volume control dial again.

Settings Menu

Turn the dial to enter the settings menu. Turn the dial again to cycle through the options, then short press to confirm a selected option.

Once any settings adjustments are completed, if there is no input from the dial for 7 seconds the device will automatically exit the settings menu and return to the home screen.

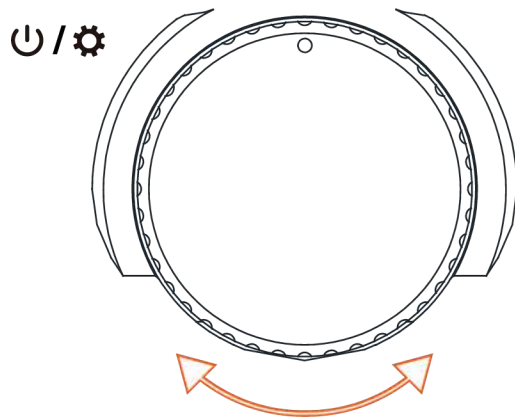

Turn



Menu

Control Options:

- Settings
- Gain Mode
- XBass Pro Mode
- Input Mode
- DSD Remastering
- XSpace Pro Mode
- K2 Technology Mode
- Digital Filters Mode
- Operation Mode
- iEMatch Mode

I) Settings

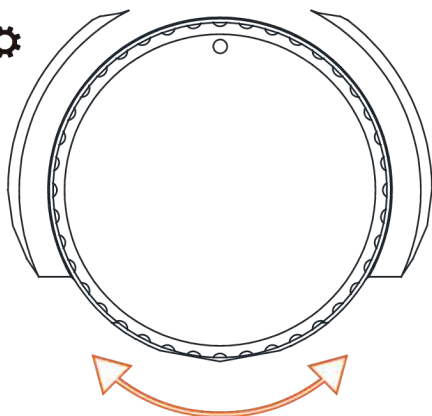
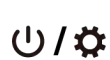

Control Options:

- Auto Off
- Tube Hour Meter
- Brightness
- Display Modes
- Playback Modes
- Volume Sync
- System
- External Sync Clock

(I) Auto Off

Turn the dial to select between the four available automatic shutdown options. The default setting is **60 mins**.

The unit automatically shuts down when there is no input signal for the specified amount of time - this may include disconnecting the source device, and pausing or stopping audio.



Timer 30 mins



Timer 60 mins



Timer 180 mins



Timer Disable

(II) Tube Hour Meter

View the cumulative Tube Mode usage time of the device. Select "Set Zero" to reset the time.



Set Zero



Back

(III) Brightness

Turn the dial to select between the three available TFT display brightness settings. The default setting is **Bright**.



Auto



Bright



Soft

(IV) Display Mode

This setting adjusts the display mode selected for the iDSD PHANTOM's home screen. The default setting is **Cover Art**.

The following four display modes can be selected:



Cover Art



Mono Sum VU Meter



Stereo Meter



Dual VU Meter

(V) Playback Mode

This setting is used to choose the system playback mode. The default setting is **Automatic**.

The following five system playback modes can be selected:



Automatic



DLNA



TIDAL



ROON



Qobuz

(VI) Volume Sync

Turn the dial to select whether Volume Sync functionality is enabled or disabled - when enabled, the iDSD PHANTOM's volume level will match the setting of the connected source device. The default setting is **Enabled**.



Enable



Disable

(VII) System

System Status

View the device's network address, host URL, WiFi IP address, and current XMOS & IoT version numbers (image below is for reference only).



System



System Status

Factory Reset

Select "Reset" to perform a factory reset. The "Factory Reset..." indicator will appear on the screen and the device will reboot once the reset has successfully completed.



Factory Reset



Reset



Back

Warning: Performing a factory reset will alter the following settings: Operating Mode defaults to Tube; Input Mode defaults to Ethernet; K2 Technology defaults to disabled; Gain Mode defaults to 0dB; Volume defaults to 70; External Sync Clock defaults to Disabled; DSD Remastering defaults to Disabled; Digital Filter defaults to BP; Screen Brightness resets to Bright; Gain defaults to 0dB; XBass Pro and XSpace Pro both default to disabled.

(VIII) External Clock Sync

Adjusts the External Clock Sync Input (31) functionality. The default setting is **Disabled**. If employing clock synchronisation mode*, ensure the appropriate clock mode is selected.

For more information about external clock input, please see (31).



Disable (Standalone)



10MHz



DARS



WCLK

Disabled (Standalone) Standalone - no external clock source is used.

10MHz Clock Connect to an external 10MHz clock source.

DARS Clock Connect to an external DARS (Digital Audio Reference Signal) clock reference.

WCLK Clock Connect to an external LRCLK / WCLK via I2S signal.

**Clock synchronisation instructions:*

1. *Clock synchronisation functionality will only be active when using the USB input.*

2. *When using USB playback:*

i) When set to 10MHz, the clock port must receive a 10MHz (9-11MHz) signal. If a 10MHz clock signal is not detected, an error will be displayed and the iDSD PHANTOM will switch back to the internal clock.

ii) When set to WLCK/DARS, the clock port input must receive the following corresponding signals:

- When the audio sample rate is a multiple of 44.1kHz (44.1kHz, 88.2kHz, 176.4kHz), the required clock signal range is 40100hz - 48100Hz,*
- When the audio sample rate is a multiple of 48kHz (48kHz, 96kHz, 192kHz), the required clock signal range is 44000hz - 52000Hz.*

(II) Input Mode

Turn the dial to select between five available input modes. The default setting is **Ethernet**.



USB



AES/EBU



BNC



Coaxial



Ethernet

Note: Please select the input channel according to your audio source. For example, when using USB input, you need to switch the input channel to "USB".

(III) K2 Technology Mode

Turn the dial to select between the three available K2 Technology modes. The default setting is **Disabled**.

For more information about K2 Technology, see (7).



Disabled



K2 Technology



K2HD Technology

(IV) Operation Mode

Turn the dial to select between the three available operation modes. The default setting is **Tube**.

For more information about operation modes, see (5).



Solid State



Tube



Tube+

(V) Gain Mode

Turn the dial to select between the three available gain modes. The default setting is **0dB**.

For more information about gain modes, see (12).

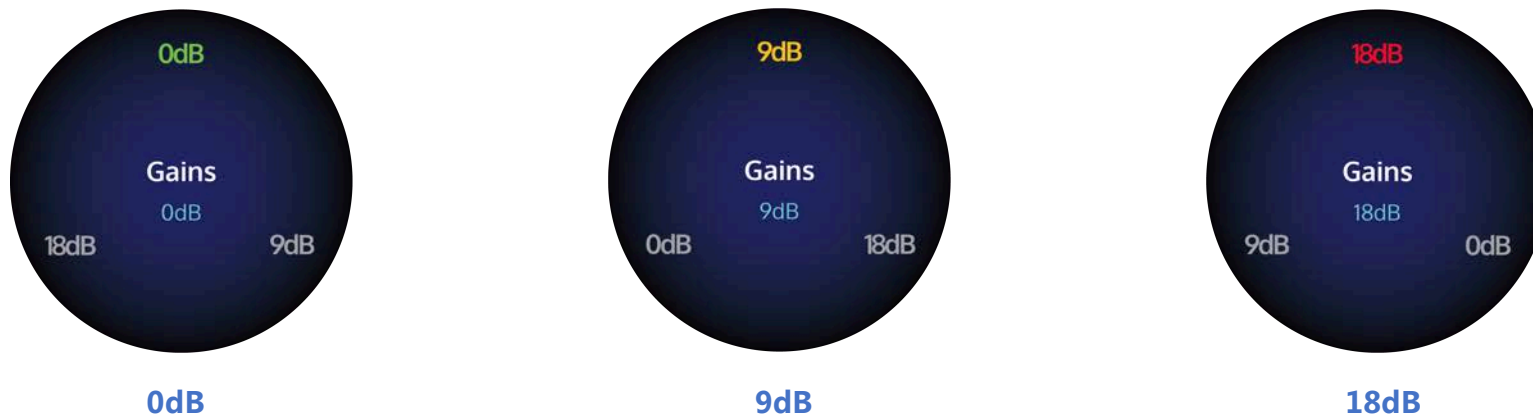

Note: Always start from 0dB and then increase the gain level gradually, to attain an enjoyable and comfortable level of volume from your headphones or speakers.

Warning: Using excessive gain can result in damage to connected headphones, and/or permanent hearing damage. AMR/iFi audio is not responsible for any damage/injury resulting from misuse of this device.

(VI) DSD Remastering

Turn the dial to select between the four available DSD Remastering modes, The default setting is **Disabled**.



Disabled



DSD2048



DSD1024



DSD512

(VII) Digital Filters Mode

Turn the dial to select between the five available digital filter options, The default setting is **BP**.

For more information about digital filters, see (6).



BP
(Bit-Perfect)



BP+
(Bit-Perfect+)



GTO
(Gibbs Transient-Optimised)



APD
(Apodising)



TA
(Transient Aligned)

(VIII) iEMatch Mode

Turn the dial to select between the three available iEMatch modes. The default setting is **Disabled**.

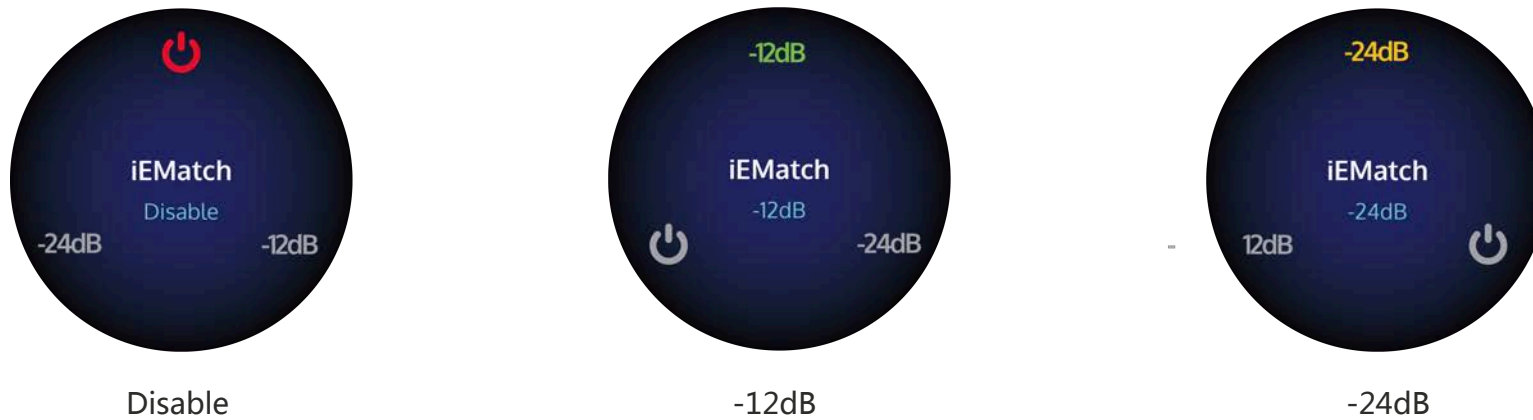

Note: iEMatch transparently reduces the output level by -12dB or -24dB, so that even the most sensitive in-ear monitors (IEMs) can be used with the iDSD PHANTOM.

iEMatch can effectively increase the dynamic range of sensitive IEMs by reducing background amplifier hiss.

(IX) XBass Pro Mode

Turn the dial to select between the four available XBass Pro modes. The default setting is **Disabled**.

For more information about XBass Pro, see (16).



Disable



XBass Pro 40Hz



XBass Pro 20Hz



XBass Pro 10Hz

(X) XSpace Pro Mode

Turn the dial to select between the four available XSpace Pro modes. The default setting is **Disabled**.

For more information about XSpace Pro, see (11).



Disable



XSpace Pro 30°



XSpace Pro 60°



XSpace Pro 90°

4. S-Balanced 3.5mm Headphone Output

Connect 3.5mm stereo headphones (compatible with single-ended TRS and balanced TRRS configurations).

5. Operation Mode Selection

The iDSD PHANTOM has 3 operation modes.

For more information about the operation status LED, see (15).



Solid State



Tube



Tube+

- **Solid-State:** A pure, solid-state circuit, using JFET circuitry for fully-discrete Class A solid-state amplification.
- **Tube:** 2 x NOS GE5670s* are engaged with the JFET circuitry switched out for Class A valve amplification.
- **Tube+:** Reduces negative feedback to a minimum. As a result, a greater amount of the tubes' natural harmonics are produced, where even order harmonics dominate.

Note: When switching between modes, there will be a brief pause as the circuit switches. To maximise tube life, the iDSD PHANTOM has a built-in intelligent monitor; after an extended period of operation (~10 min) in Solid-State mode, the tubes will switch off. If the tube circuit is shut-off, upon switching back to Tube/Tube+ mode, the tubes will need to warm up again (~30 s) as if the unit was powered up from OFF. Music will continue to play via the solid-state section until the tubes are ready.

Tip: The iDSD PHANTOM's predecessor, the Pro iDSD, was the world's first headphone/preamp with real-time switching between transistor and tube. For the first time, one could enjoy both the sound of solid-state and tube amplification in a single package (rather than as an 'effect type' add-on within an otherwise conventional solid-state design) and be able to switch in real time. For some recordings and headphones/loudspeakers, solid-state may sound more lively. For others, Tube and Tube+

Tip: New Old Stock General Electric 5670 x 2. Each GE5670 tube has undergone a special rejuvenation process and the tube circuit is specially-designed for long life. This means the tubes should offer many years of enjoyment. Note that a 5670 to 6922/6DJ8 adapter is required in order to use these tubes (included).

6. Filter Mode Selection

The iDSD PHANTOM has a comprehensive suite of digital filters. With certain filters engaged, PCM content may be up-converted to a maximum of 16x the original rate, to 705.6/768kHz.

Short press the button to cycle through the following 5 digital filters. The display will show the corresponding digital filter information, listeners can freely select different digital filter modes:

Filters	Features
Bit-Perfect	No digital filtering, no pre or post-ringing
Bit-Perfect+	No digital filtering is applied, one tap, SINC roll-off is corrected
Gibbs Transient-Optimised	Up-sampled to 352.8/384kHz, minimum filtering, no pre-ringing, minimum post-ringing, 32 taps
Apodising	Modest filtering, no pre-ringing, modest post ringing, 128 taps
Transient Aligned	Max filtering, max pre-ringing, maximum post-ringing, 16,384 taps

Note: If the GTO filter is selected, the only sample rate indicator showing will be 352.8/384kHz, indicating the upsampling operation of this filter. When both K2HD mode and GTO filter are enabled, the sampling frequency of GTO is 192kHz.

7. K2 Technology Mode Selection

The iDSD PHANTOM incorporates JVCKENWOOD's K2 Technology, designed to enhance sound quality by restoring altered or degraded digital audio. This processing brings the sound closer to the quality of the original master recording.

After a short press of the button, turn the dial to select between the three available K2 Technology modes:





Disable



K2 Technology



K2HD Technology

K2 Mode	Features
	<p>Collective term for JVCKENWOOD's K2 Technology, used here to denote K2 technology processing without up-sampling.</p> <p>The audio file format supported by 'K2' mode is PCM, sampling frequency 44.1~96kHz, when the audio file format > PCM 96kHz, 'K2' mode is not applicable, and it will be switched to 'K2HD' mode automatically.</p>
	<p>The audio file format supported by 'K2HD' mode is PCM with sampling frequency 44.1~192kHz, and it can up-convert audio files \leq PCM 176.4kHz to 176.4/192kHz.</p> <p>'K2HD' mode is not compatible with native DSD audio file format, "K2HD" mode cannot be enabled when the audio file format played is in DSD format.</p> <p>'K2HD' mode = K2+DSD upscaling/GTO upscaling</p>

Tip: When K2 mode is enabled, it will automatically switch to K2HD mode when the audio sample rate played is >96kHz; when the audio sample rate played is ≤96kHz, it will automatically resume 'K2' mode.

Tip: 'K2HD' mode supports GTO digital filter and DSD upsampling only. When K2HD mode and GTO filter are enabled at the same time, the sampling frequency of GTO filter is 176.4/192kHz, and when the playback audio sampling rate > 176.4/192kHz, the digital filter will automatically switch to Bit-Perfect and disable 'K2HD' mode automatically. When K2HD mode is not enabled, the sampling frequency of GTO filter is 352.8/384kHz.

When 'K2' mode and GTO filter or DSD upsampling are enabled at the same time, 'K2' mode will be automatically switched to 'K2HD' mode, and the sample rate of the audio played back will be higher than 176.4/192kHz. When the playback audio sample rate is >176.4/192kHz, 'K2HD' mode is automatically turned off; when the playback audio sample rate is ≤176.4k/192Hz, 'K2HD' mode is automatically restored.

**"K2 TECHNOLOGY" and "K2HD" are trademarks or registered trademarks of JVC KENWOOD Corporation."*

8. TFT Display

The TFT display shows the current input channel, sample rate, external clock input, Nexis App connection, Operation Mode, iEMatch, volume level, audio format, DSD Remastering, gain mode, XSpace Pro, XBass Pro, Clock, 'K2' mode and digital filter.



9. Balanced XLR L/R, Stereo Single-Ended 6.3mm + and - Phase Output

Balanced

XLR – 3 Pin x 2

6.3mm TRS x 2 (iFi SEC balanced system)

Note: The iFi SEC (Single-Ended Compatible) balanced connection uses one 6.3mm jack for L+/R+ (left jack) and the other for L-/R- (right jack) with both sleeves being Ground (GND). This makes it directly compatible with standard single-ended (non-balanced) headphones. With the correct headphone cable it allows a balanced connection using two 6.3mm plugs.

Single-Ended

6.3mm TRS x 2

Please use the left jack for single-ended headphones (positive phase). You can, however, drive two separate headphones simultaneously if desired by using the right jack (negative phase) for the additional headphone.

10. Stereo Balanced XLR Headphone Output

Connect XLR – 4 Pin Balanced headphones.

11. XSpace Pro Matrix Mode Selection

There are two separate Analogue Signal Processing (ASP) matrix circuits that switch automatically between headphone and loudspeaker use.

After a short press of the button, turn the dial to select between the following XSpace Pro mode:



Disable



XSpace Pro 30°



XSpace Pro 60°



XSpace Pro 90°

Tip: XSpace Pro Holographic for headphones is not based on a standard cross-feed system, as found in some high-end headphone amplifiers. Many so called '3D systems' are DSP based. This artificially affect the sound and adds unwanted reverb in order to simulate a spacious type of sound.

For Headphones: (Headphone Outputs)

- **OFF : XSpace Pro** Holographic is disabled This allows the 'direct' sound to be enjoyed.
- **30° Loudspeaker Angle:** This matrix simulates a narrow loudspeaker placement (e.g. loudspeakers either side of a large computer monitor) and can also be used for recordings that have been artificially enhanced for spaciousness or early 'Ping-Pong' type stereo recordings.
- **60° Loudspeaker Angle:** This matrix simulates traditional 'textbook' loudspeaker placement in an equilateral triangle.
- **90° Loudspeaker Angle:** This matrix simulates a wide loudspeaker placement favoured by some audiophiles. It may also be used to enhance recordings that lack spaciousness (some minimalist 'single point' recordings fall into this group).

*Note: When using the headphone outputs, the **XSpace Pro** Holographic matrix for headphones is engaged. When using the line outputs (RCA/XLR), the **XSpace Pro** Holographic matrix for loudspeakers is engaged.*

Traditional cross-feed tends to produce an 'out of head' sound, but with much diminished spatial components and a narrower soundstage, sometimes almost approaching mono. Most DSP-based 3D designs produce an unnatural, echo-like sound, which may initially be impressive, but soon becomes tiring.

*By contrast, **XSpace Pro** Holographic for headphones, provides not only 'out of head' placement of the sound sources, but renders the whole sound field in a manner that strongly parallels listening to loudspeakers in a normal room, all achieved without the added reverb.*

For Loudspeakers: (Line Outputs)

The **XSpace Pro** Holographic for Loudspeakers is an analogue matrix circuit that has two distinct functions:

1. It corrects the fundamental spatial distortion in stereo recording
 2. It increases the perceived width of the soundstage beyond the width dictated by the loudspeaker placement
- **OFF:** **XSpace Pro** Holographic is disabled (this allows the 'direct' sound to be judged).
 - **30°:** This matrix corrects the spatial distortion caused by the recording/mixing/mastering process and restores the original width of the soundstage. This is the recommended default setting if the loudspeakers are already ideally placed for imaging.

- **60°**: This matrix corrects the spatial distortion caused by the recording/mixing/mastering process and adds an approximate 30° to the perceived width of the soundstage. Thus, loudspeakers with narrow placement (e.g. loudspeakers closely located either side of a TV set) can offer a soundstage that extends beyond the left and right past the loudspeakers and is close to the ideal placement.
- **90°**: This matrix corrects the spatial distortion caused by the recording/mixing/mastering process and adds an approximate 60° to the perceived width of the soundstage. This is close to the 'wide' placement preferred by some audiophiles.

*The **XSpace Pro** Holographic circuit for loudspeakers corrects a distortion of the **XSpace Pro** sound field caused by recording via microphones and playback via loudspeakers. This sound field distortion was first described by Alan Dower Blumlein (the inventor of stereophonic sound) and corrected by EMI in early 'Stereosonic' recordings.*

*However, the original Stereosonic circuit tended to result in a narrower soundstage than if recorded straight and often overcompensated distortion of the soundstage perspective. iFi's **XSpace Pro** Holographic systems avoid this and instead, allow an expansion of the width of the sound stage.*

Tip: These modes can also be used to enhance the imaging of recordings that offer poor spatiality.

12. Gain Mode Selection

After a short press of the button, turn the dial to select between the following gain modes:

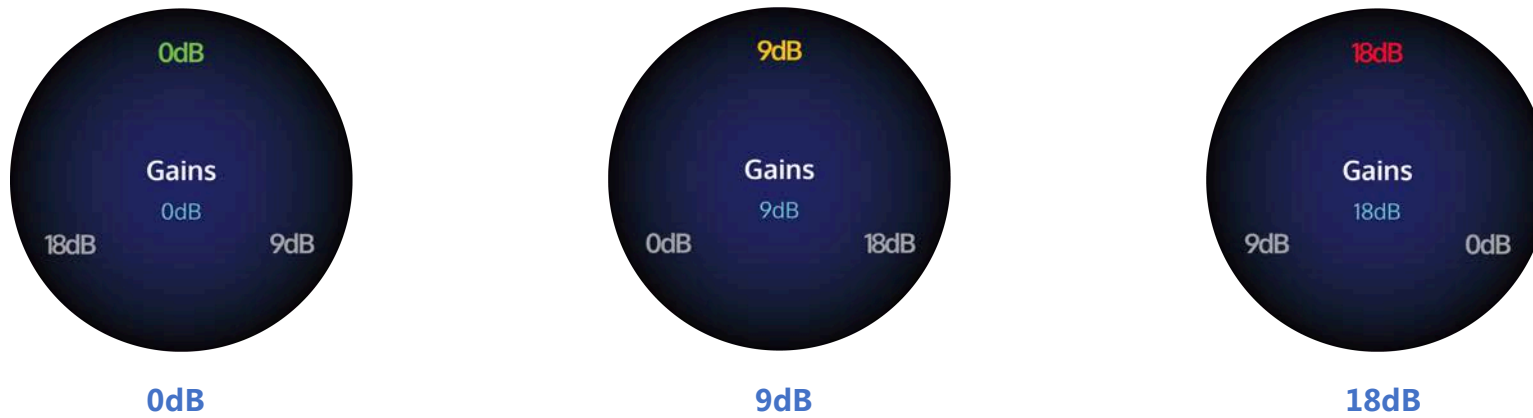

Tip: Use the lowest gain possible for the best sound. At normal listening levels, the volume control should be around 12 o'clock. Increase the gain if the 12 o'clock position does not provide satisfying listening levels.

Note: Please be aware that the iDSD PHANTOM can output >14V in Unalanced mode and over 27V in Balanced mode. These levels are very high and can damage many headphones and/or drive most amplifiers (if used as a line-stage) into very hard clipping. Damage to headphones and/or loudspeakers may result from excessively high volume settings.

13. Analogue Volume Control Dial

Turn the dial to control the volume. The analogue volume control in the iDSD PHANTOM is audibly superior to any digital volume control.

Tip: For normal listening levels, the volume control should be between 10 and 2 o'clock. Adjust the gain upwards if the volume is unsatisfactory. If one cannot turn up the volume to even 10 o'clock (at the lowest gain setting), please connect the headphone to the iEMatch balanced 4.4mm or single-ended 3.5mm connections, which are matched to high-sensitivity headphones such as in-ear-monitors and other high-sensitivity modern headphones designed to operate from portable devices.

14. Balanced 4.4mm Headphone Output

Connect balanced 4.4mm headphones.

Tip: If possible, use balanced headphones to take full advantage of the true balanced nature of the iDSD PHANTOM circuitry.

15. Operating Status LED

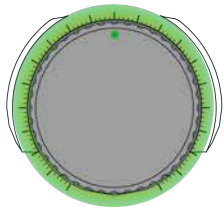

Warming-up
(Green)

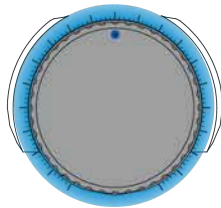

Solid-State
(Blue)

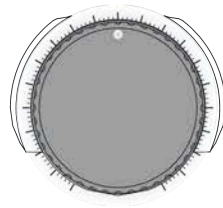

Tube
(white)

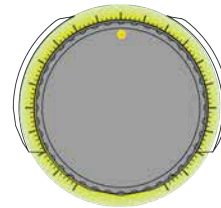

Tube+
(Yellow)

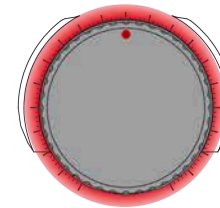

Protection
(Red)

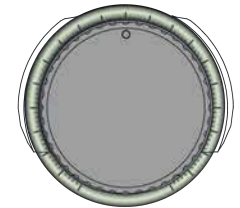

Mode switching
(Flashing)

16. XBass Pro Mode Selection

After a short press of the button, turn the dial to select between the following **XBass Pro** modes:



Disable



XBass Pro 40Hz



XBass Pro 20Hz



XBass Pro 10Hz

Different recordings and different headphones exhibit different frequency responses. **XBass Pro** is an analogue signal processing (ASP) circuitry. It is sonically superior to Digital Signal Processing (DSP) systems. **XBass Pro** is tailored to correct the bass deficiency in the headphone/loudspeaker and achieve the desired level. It is NOT a traditional tone or loudness control. The maximum boost is 12dB and the frequency at which this maximum boost is achieved is as follows:

- **XBass Pro OFF** is disabled (this allows the 'direct' sound to be enjoyed).
- **XBass Pro 10Hz** for headphones/loudspeakers missing only the very lowest bass (below 40Hz).
- **XBass Pro 20Hz** for headphones/loudspeakers missing some bass (below 80Hz).
- **XBass Pro 40Hz** for headphones/loudspeakers missing substantial bass including some mid-bass (below 160Hz).

*Note: Please be careful with the **XBass pro** settings especially at high gain and high volume control settings, as even the most power-hungry headphones may be damaged by the power of the iDSD PHANTOM.*

*Tip: The **XBass pro** circuit is designed to correct different levels of bass deficiency inherent in many headphones/loudspeakers. It is NOT a gimmick to add artificial bass to recordings. Great care has been taken in the design to ensure there is no degradation of sound quality.*

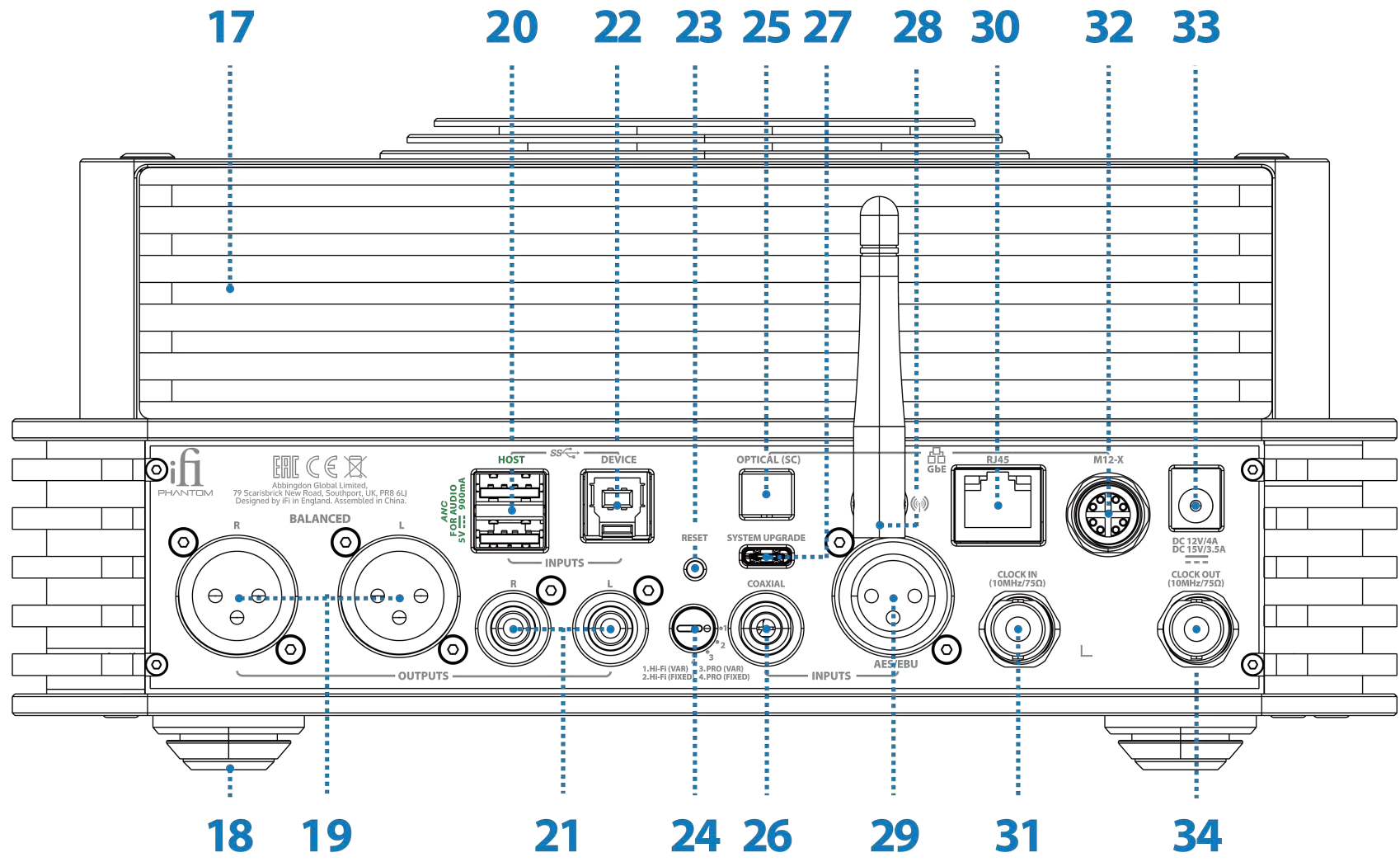

17. Magnetic Metal Cooling Back Cover

This attachment can also be used to cover the front output panel when not in use or when the iDSD PHANTOM is used as a preamplifier.

18. Dual Damped Anti-Vibration Foot Post

Base support, please set the iDSD PHANTOM on a flat surface.

Tip: The double layer damped anti-vibration footbed is specifically designed to provide the ultimate in vibration control. It consists of a double sandwich of a customised elastomer (silicone layer and a copolymer layer of ethylene and vinyl acetate) and a metal alloy (AL-Mg-Si aluminium alloy with hollow internal structure), allowing for minimisation of resonance in the iDSD PHANTOM chassis.

19. Balanced XLR 3-Pin Line Output

Balanced XLR line output. This output may be connected to an active speaker or balanced amplifier.

Please ensure the connected device does not connect pin 3 (negative phase signal) to ground.

20. Host USB-A x 2 Input

The 'Pure Port' USB-A ports support bi-directional input and output transmission. They are compatible with USB devices and support both USB 2.0 and USB 3.2 standards.

- a) Output - Connect to USB DAC (Data & Power)
- b) Input - Connect to HDD, USB DISK etc.

These two USB ports have ANC technology built- in.

21. Single-Ended RCA Analogue Line Output

This is a variable-level analogue output via RCA > RCA or other single-ended interconnects. You can use this to connect to active speakers or amplifiers.

22. Device USB-B Input

For connecting a PC host such as a laptop or a server.

23. Forced Factory Reset

If the device becomes unresponsive (no feedback for any operation), long press for $\geq 3s$ and WAIT for $\sim 5mins$; the iDSD PHANTOM will force a shutdown reset.

DO NOT POWER OFF!

Loss of power during this period may damage your device and leave it unusable.

24. Output selector: HiFi Fixed/HiFi Variable/Pro Fixed/Pro Variable

It is possible to set the signal output to different levels for home or studio use. Industry standard signal output levels apply; balanced output is $\sim 4.6V$ (HiFi Fixed mode) and $\sim 11.2V$ (Pro Fixed mode).

Variable is adjusted via the front volume control. With the volume control at maximum the same signal levels listed above are achieved.

25. Optical (SC) Ethernet Input

Connect with an SC single mode optical network cable.

26. S/PDIF (Coaxial) Digital Input

For connecting an S/PDIF source such as Apple TV, Google Chromecast, PS5, a high-end CD transport, etc.

Tip: To connect to the iDSD PHANTOM via a S/PDIF coaxial connection, use a 3.5mm TS jack (Tip - Signal; Sleeve - GND).

Tip: The S/PDIF standard supports PCM only up to 192kHz.

27. USB-C System Upgrade Port

Used for system firmware upgrades, if the normal IoT update method is unavailable.

28. Wi-Fi antenna

Using the iFi Nexis App, connect the iDSD PHANTOM to the local WiFi system to stream Spotify Connect, Tidal Connect, Qobuz Connect, Napster, QQ Music and many more.

It is also possible to enjoy Airplay network audio playback from iPhone, iPad and Mac computers.

Almost every music format, from MP3 to FLAC to DSD, can be played directly through the iDSD PHANTOM via the iFi Nexis App or suitable server software.

29. AES/EBU (XLR) Digital Input

For connecting an XLR single link source such as a high-end CD transport or a Digital Audio Workstation (DAW).

30. RJ45 Ethernet Input

Use a wired network cable with an RJ45 connector for a direct wired connection from a router or Network Attached Storage (NAS) source.

Stream Spotify Connect, Tidal Connect, Qobuz Connect, Napster, QQ Music and more using the iFi Nexus App.

31. External Clock Input

To utilise an external clock input, set this to 'Enabled' . For external clock settings, please refer to (3-I-VIII).

With 'External Clock' set to 'Enabled', the iDSD PHANTOM will automatically detect the external clock input signal.

If no input 10 MHz clock signal is detected or the external clock signal is not recognised, the iDSD PHANTOM will automatically switch back to the internal clock, and the clock icon in the of the display will turn red.

A sine or square wave signal may be used, 1Vpp nominal, 75Ω.

32. M12-X Ethernet Input

Connect a network cable with an M12 X-code 8-pin connector.

33. DC Power Supply Input

DC 12V/4A - 15V/3.5A* power input. Please connect the iDSD PHANTOM with the enclosed power supply.

Tip: Any 9v to 18v DC power source with a typical 25W (maximum 75W) rating can be used with the iDSD PHANTOM (including vehicular, RV and boat-based 12V DC power). The iDSD PHANTOM uses double-conversion power supplies that make it impervious to power supply noise and related problems. However, we strongly recommend the use of the included iPower Elite. It offers the latest in power supply technology and is better and cleaner than battery and aftermarket linear power supplies.





34. External Clock Output

To utilise the 10MHz external clock output, set this to 'Enabled' .

If no output 10MHz clock signal is detected, or the external clock signal is not recognised, this setting will automatically switch back to 'Disabled' .

A sine or square wave signal may be used, 1Vpp nominal, 75Ω.

Set up your iDSD PHANTOM using our iFi Nexis App



Download the Nexis app for added features and future updates

Please search for "iDSD PHANTOM" within the iFi Nexis app.

The iFi Nexis app helps you to use all the features and settings of the iDSD PHANTOM, such as OTA upgrades*, remote control** and more.

**OTA (Over-the-Air) technology enables automatic firmware updates via the network.*

***Provides listeners with a convenient and easy-to-use way to control their device as an alternative to the traditional remote control, for adjusting all the functions and settings of the iDSD iDSD PHANTOM more easily, conveniently and freely. The iFi Nexis app connects to it via Wi-Fi or Bluetooth (selectable in the app).*



Scan the QR code to view the official iFi audio iDSD PHANTOM video on YouTube.

Cautions

1. Avoid extreme heat, cold and humidity.
2. Avoid dropping or crushing the iDSD PHANTOM.
3. If you experience discomfort or pain, try lowering the volume or discontinuing use temporarily.
4. Always check the actual output volume on your earphone, headphone, or loudspeakers before playing audio, as many music player software and operating systems do not appropriately apply industrial standards governing volume control (e.g., USB Device Class Definition for Human Interface Devices). If in doubt, before playing any music, turn off volume synchronisation feature on the iFi Product and bring the volume down to the lowest setting.

Prolonged Heat Exposure

Your iFi Product may become very warm during normal use. It is important to keep your iFi Product on a hard, stable, and well-ventilated work surface when in use.

SPECIFICATIONS

Digital

Hi-Res Support

PCM 768kHz; DSD512 (DSD2048 with Remastering)

Headphone Output Power

Balanced (RMS)

$\geq 3,781\text{mW}/11\text{V}$ (@ 32 Ω); $\geq 564\text{mW}/18.4\text{V}$ (@ 600 Ω)

Balanced (Max)

$\geq 7,747\text{mW}/15.7\text{V}$ (@ 32 Ω); $\geq 558\text{mW}/18.3\text{V}$ (@ 600 Ω)

Single-Ended (RMS)

$\geq 2,311\text{mW}/8.6\text{V}$ (@ 32 Ω); $\geq 144\text{mW}/9.3\text{V}$ (@ 600 Ω)

Output Impedance

Balanced <math><2\Omega</math>

Single-Ended <math><1\Omega</math>

THD+N

Balanced <math><0.005\%</math> @ 16 Ω (2.4V, 20-20kHz)

Single-Ended <math><0.01\%</math> @ 16 Ω (1.27V, 20-20kHz)

SNR

Balanced $\geq 116\text{dBA}$ @ 600 Ω (Max output, 20-20kHz)

Single-Ended $\geq 114\text{dBA}$ @ 600 Ω (Max output, 20-20kHz)

DNR

Balanced $\geq 116\text{dBA}$ @ 600 Ω (10-20kHz)

Single-Ended $\geq 115\text{dBA}$ @ 600 Ω (10-20kHz)

Output Noise

Balanced <math><30\mu\text{V(A)}</math> @ 600 Ω (Max output, 20-20kHz)

Single-Ended <math><20\mu\text{V(A)}</math> @ 600 Ω (Max output, 20-20kHz)

General

Power Consumption	<30W idle; 60W max.
Dimensions	256 x 185 x 120mm (10.1 x 7.3 x 4.7")
Net Weight	3.75kg (8.33 lbs)
Limited Warranty	12 months*

Test conditions:

Gain = 0dB, 0.775V(0dBu) with 300 Ohm load unless stated otherwise

SNR Balanced re 25V, SNR SE re. 13V

*12 months typical or as permitted/required by local reseller laws.

"K2 Technology" and "K2HD" are trademarks or registered trademarks of JVCKENWOOD Corporation.

Specifications are subject to change without notice.

The image colour may differ from the actual product due to lighting, please refer to the product for accuracy.