

ifi

ican  
PHANTOM

User Manual



**Thank you for purchasing this Phantom series iCAN. The iCAN Phantom is both :**

- (I) a professional analogue headphone amplifier**
- (II) a fully-fledged, high-end stereo preamplifier**
- (III) an audiophile-grade energiser for electrostatic headphones**

***WARNING:** The iCAN Phantom is VERY POWERFUL and can offer large amounts of sub-bass boost. As a starting point, always use the lowest gain possible and start with the volume set low and **XBass** set to OFF. iFi is not responsible for any ancillary equipment damage caused by the iCAN Phantom.*

## **FEATURES**

- The ultimate analogue headphone amp from world-leading head-fi manufacturer iFi Audio
- Also performs as a high-end stereo preamplifier to connect to a power amp and speakers
- Pure Wave PRO fully differential balanced circuit design delivers ultra-low distortion
- Two discrete input stages, switch between solid state and GE 5670 vacuum tubes in real time
- Remarkable power-up to 15,000mW to drive the toughest headphone loads with ease
- Delivers 14V in Unbalanced mode and 27V in Balanced mode
- Adjustable gain and load impedance plus iEMatch output attenuation to suit all headphone/IEM types
- Pro iESL energiser technology with six voltage settings for electrostatic headphones
- Capacitive battery power supply eliminates mains-borne noise from the audio signal
- Multi-level XSpace and XBass analogue processing modes for headphones and speakers
- Exemplary build quality, comprehensive connectivity and informative colour TFT display

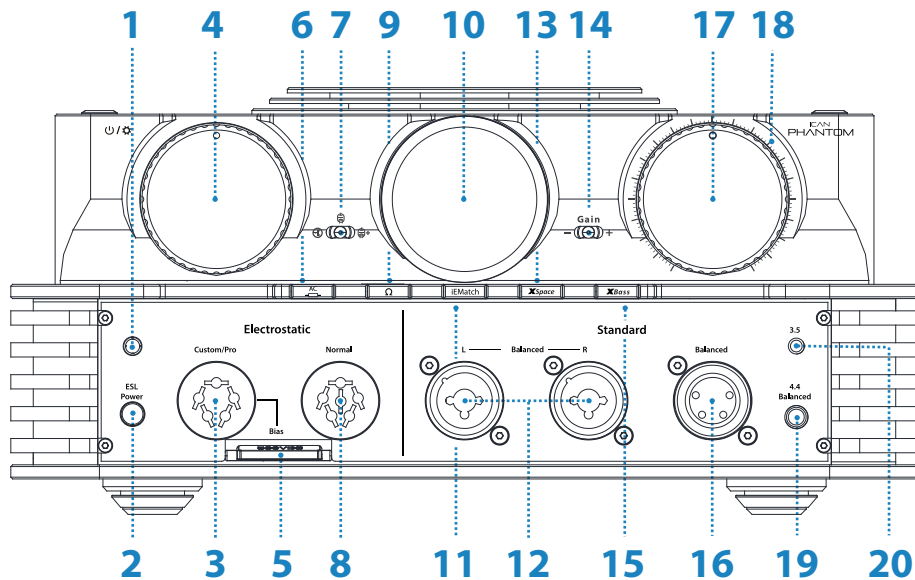

- |  |       |   |         |   |      |
|--|-------|---|---------|---|------|
| <b>1. Electrostatic Power LED</b>              | P.4   | <b>8. Normal Bias ESL Headphone Output</b>                                | P.11    | <b>14. Gain Selection</b>                       | P.15 |
| <b>2. Electrostatic Headphone ON/OFF</b>       | P.4   | <b>9. Impedance Adjustment</b>  | P.11    | <b>15. XBass Adjustment</b>                     | P.16 |
| <b>3. Pro/Custom Bias ESL Headphone Output</b> | P.4   | <b>10. TFT Display</b>  | P.11    | <b>16. Stereo Balanced XLR Headphone Output</b> | P.16 |
| <b>4. Power/Mute/Input/Menu</b>                | P.4-8 | <b>11. iEMatch Adjustment</b>   | P.12    | <b>17. Analogue Volume Control Dial</b>         | P.16 |
| <b>5. Bias Memory Card Slot</b>                | P.9   | <b>12. Balanced XLR L/R, Stereo Unbalanced 6.3mm - and + Phase Output</b> | P.12    | <b>18. Operating Status LED</b>                 | P.17 |
| <b>6. AC Termination Adjustment</b>            | P.9   | <b>13. XSpace Adjustment</b>  | P.13-15 | <b>19. Balanced 4.4mm Headphone Output</b>      | P.17 |
| <b>7. Operation Mode Selector</b>              | P.10  |   |         | <b>20. Unbalanced 3.5mm Headphone Output</b>    | P.17 |

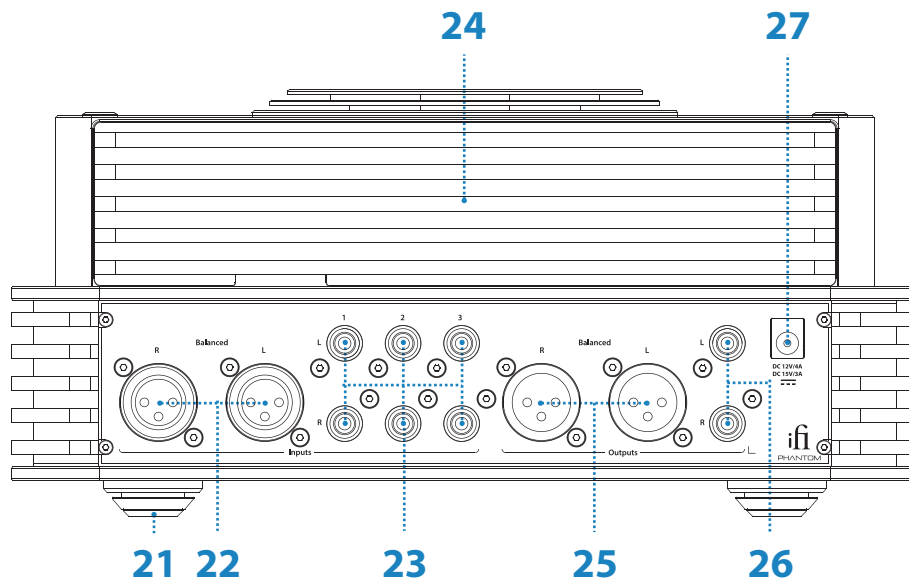

- 21. Dual Damped Anti-Vibration Foot Post
- 22. Dual Balanced XLR 3-Pin Signal Line Input
- 23. Unbalanced RCA 1-3 Signal Input
- 24. Bias Setting Memory Card Storage Back Cover
- 25. Balanced XLR 3-Pin Line Output
- 26. Unbalanced RCA Line Output

P.17  
P.18  
P.18  
P.18  
P.18  
P.18

**27. DC Power Supply Input**

- Quick Set-Up
- iFi Nexis App & Cautions
- Design Notes from the AMR/iFi Research
- Specifications

P.18  
P.19-23  
P.24-25  
P.26-31  
P.32



## 1. Electrostatic Power LED

Lights up when the Electrostatic headphone power switch is turned on.

## 2. Electrostatic Headphone ON/OFF

Turns on/off the electrostatic headphone power, off by default.

*Tip: If the "ESL Default" is not set to "ON", you will need to turn it on manually to use an electrostatic headphone.*

## 3. Pro/Custom Bias Electrostatic Headphone Output

5-pin socket for Pro Bias headphones, 500V to 640V adjustable Bias Voltage.

## 4. Power/Mute/Input/Menu

Controls:

- Power ON/OFF (short press)
- Mute (single tap)
- Input selector (turn)
- Menu settings (double tap)

### Power ON/OFF

Short press dial for 1s to switch on, long press dial for 3s to switch off.

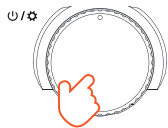

Short press



Power ON

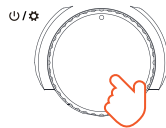

Long press



Power OFF

## Mute

Short press the dial to mute. To unmute, press it again or turn the volume dial (item 17).

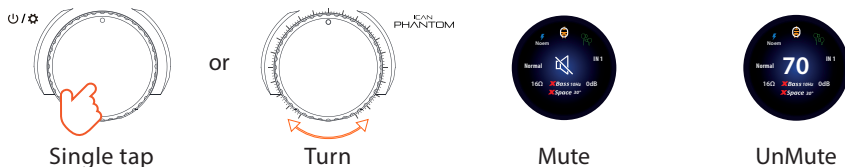

## Input selector

Turn the dial to select between the following inputs:



## Menu settings

Short press twice to enter the menu settings, turn the dial to cycle through the options, short press to confirm option. After confirming, if there is no operation for 4-5 seconds the device will automatically exit menu settings and return to the main interface.

### Options:

- ESL Default      - Brightness      - Tube Runtime      - Auto off
- Zero Mute      - About      - Reset      - Exit



### (i) ESL Default

Turns ESL Default on/off, off by default.

When ESL Default is set to "ON", the Electrostatic headphone power (item 2) is automatically switched on every time the power is switched on (item 4) and no longer needs to be switched on manually.

### (ii) Brightness

TFT display screen brightness setting, default setting "High".



**AUTO** Sleep mode. If no operation is performed within 10s, the display will turn off.

**Low** Low brightness mode. The display brightness always remains low.

**High** High brightness mode. The display brightness always remains high.

### (iii) Tube Runtime

You can view the elapsed time of the vacuum tubes, or reset the timer to zero. This may be done when a new pair of vacuum tubes is inserted.



Running time



Time zero



### (iv) Auto off

Automatic shutdown setting. The default setting is 1 hour. The unit automatically shuts down when there is no output signal, or when playback is paused or stopped within the set time.



Turn off automatic shutdown



Timer 30 min



Timer 1 hour



Timer 3 hour

### (v) Zero Mute

Turns Zero Mute for the volume control on/off, on by default.

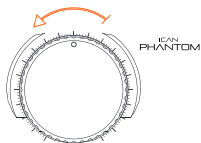

OFF



ON

Turn (item 17)

**OFF** When the volume dial is at its lowest level, 0 is displayed and music is output at its lowest level.

**NO** When the volume dial is at its lowest, the mute icon is displayed and the output is switched to mute.

*Tip: With Zero Mute set to "off", a short press on the dial (item 4) will still mute the device.*

## (vi) About

View the device name and the current firmware version number.



## (vii) Reset

Select Yes to perform a factory reset. The device reboots after a successful operation.



Reset in progress



Reset complete

*Warning: Factory reset will clear all current settings and restore the menu settings to their default state; circuit mode is solid-state by default; volume is 71 by default; input is set to RCA 1 (IN 1 on display) by default; impedance is 96Ω by default; gain is 0dB by default; screen brightness is high by default; factory reset is NO by default.*

## (viii) Exit

Exit the menu, return to the main screen or return to the previous screen.

## 5. Bias Memory Card Slot

Before using the Pro/Custom bias electrostatic headphone output port, select the bias voltage memory card according to the table below or according to the recommendations given by the electrostatic headphone manufacturer and the specifications of your electrostatic headphone.

### Bias voltage usage:

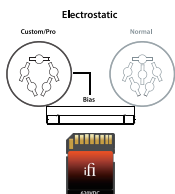

500V	Sennheiser Orpheus HE-90, Monoprice Monolith Electrostatic
540V	Sennheiser HE-60, King Sound KS-H2/3/4
580V	Stax Pro Bias ESHP, Audeze crbn, Nectar HiveX, Muamp, VOCE
600V	Koss ESP/950 & DROP Koss ESP/95X, Jade
620V	HIFIMAN Shangri-La/La jr/Jade 2
640V	Sennheiser HE 1, HIFIMAN Shangri-La/La jr/Jade 2, Phenomenon Libratum/Canorum

*Tip: In the bias memory card holder/front cover (item 24), there are six bias voltage setting memory cards from 500VDC to 640VDC.*

## 6. AC Termination Adjustment

Adjust the electrostatic headphone output mode, which can be adjusted with Electrostatic headphone power (item 2) turned on.



OFF



Normal only



Pro/custom only



Normal & Pro/custom

*Tip: AC termination affects the operation of the headphone by either making the bias node that is shared between both channels high impedance, or low impedance for audio signals. This affects a complex set of parameters, but audibly mainly affects the presentation of the XSpace Holographic Matrix System. AC Termination ON means the bias node has low impedance. OFF is high impedance.*

*Tip: When a bias memory card is not inserted into the memory card slot (item 5), the Pro/Custom bias ESL headphone output socket cannot be used, and PRO/FULL modes cannot be adjusted.*

## 7. Operation Mode Selector

The iCAN Phantom has 3 operation modes:



 **Solid-State:** is a pure, solid-state circuit and uses J-FETs and is fully-discrete Class A.

 **Tube:** 2 x NOS GE5670s\* are engaged with the J-FET circuitry switched out for valve Class A operation.

 **Tube+:** reduces negative feedback to a minimum. As a result, a greater amount of the tubes' natural harmonics are produced, where even order harmonics dominate.

*Note: Upon switching between modes, there will be a brief pause as the circuit switches. To maximise tube life, the iCAN Phantom has a built-in intelligent monitor; after an extended period of operation (~10 min) in Solid-State mode, the tubes will switch off. If the tube circuit is shut-off, upon switching back to Tube/Tube+ mode, the tubes will need to warm up again (~30 s) as if the unit was powered up from OFF. Music will continue to play via the Solid-State section until the tubes are ready.*

*Tip: The iCAN Phantom's predecessor, the Pro iCAN, was the world's first headphone/preamp with real-time switching between transistor and tube. For the first time, one could enjoy both the sound of Solid-State and Tubes in a single package (rather than as an 'effect type' add-on within an otherwise conventional Solid-State design) and be able to switch in real time. For some recordings and headphones/loudspeakers, Solid-State may sound more lively. For others, Tube and Tube+ (especially Tube+) will sound more luxurious.*

*Tip: New Old Stock General Electric 5670 x 2. Each GE5670 tube has undergone a special rejuvenation process and the tube circuit is specially-designed for long life. This means the tubes should offer many years of enjoyment. Note that a 5670 to 6922/6DJ8 adapter is required in order to use these tubes (included).*

## 8. Normal Bias Electrostatic Headphone Output

6-pin socket for normal bias headphones (eg. previous generation Stax units). 230V Bias Voltage.

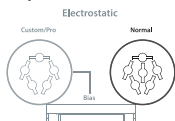

*Tip: If a bias memory card is not inserted into the bias memory card slot (item 5), the PRO and FULL modes cannot be adjusted.*

## 9. Impedance Adjustment

The impedance response can be adjusted from 16Ω to 96Ω. It is 96Ω by default. This impedance describes the load impedance for the driving amp with a "standard" electrostatic headphone connected.

Lower impedance settings create a greater step-up and will produce a louder sound level at the same headphone amplifier volume setting.

Lower impedance settings are a more difficult load for the driving amplifier.

*Tip: Please adjust to suit listening preferences, however, in most cases the higher impedance setting is recommended.*

## 10. TFT Display



The TFT Display shows the Input, Operation Mode, Bias Voltage, iEMatch, AC Termination, Volume, Impedance, XBass, XSpace and Gain Settings.



## 11. iEMatch Adjustment

The iEMatch adjustment button. off by default.



This feature reduces the output level, so that even the most sensitive In-Ear-Monitors (IEMs) can be matched to the iCAN Phantom.

iEMatch can increase the dynamic range of sensitive IEMs by reducing background amplifier hiss.

*Tip: S-Balanced 3.5mm headphone output reduces the level by 6dB and balanced 4.4mm headphone output lowers it by 12dB.*

## 12. Balanced XLR L/R , Stereo Unbalanced 6.3mm - and + Phase Output Balanced

XLR – 3 Pin x 2

6.3mm TRS x 2 (iFi SEC balanced system)

*Note: The iFi SEC (Unbalanced Compatible) balanced connection uses one 6.3mm jack for L-/R- (left jack) and the other for L+/R+ (right jack) with both sleeves being Ground (GND). This makes it directly compatible with standard non-balanced headphones. With the correct headphone cable it allows a balanced connection using two 6.3mm plugs.*

### UnBalanced

6.3mm TRS x 2 (please use the right jack for unbalanced headphones. You can, however, drive two separate headphones simultaneously if desired).

### 13. XSpace Adjustment

There are two separate Analogue Signal Processing (ASP) matrix circuits that switch automatically between headphone and loudspeaker use.



*Note: XSpace Holographic for Headphones is not based on a standard cross-feed system, as found in some high-end headphone amplifiers. Many so called '3D systems' are usually DSP based. This artificially effects the sound and adds unwanted reverb in order to simulate a spacious type of sound.*

#### For Headphones: (Headphone Outputs)

XSpace Holographic for Headphones® is an analogue matrix to 'undo' the negative sonic impact of headphone listening with recordings that were originally made for loudspeakers (as is the case for >95% of recordings). When listening with headphones this 'In Head Localisation' (sound is 'located' in the centre of one's head) can often lead to listening fatigue and possibly even a little nausea.

- i. **OFF:** XSpace Holographic is disabled This allows the 'direct' sound to be enjoyed.
- ii. **30° Loudspeaker Angle:** This matrix simulates a narrow loudspeaker placement (e.g. loudspeakers either side of a large computer monitor) and can also be used for recordings that have been artificially enhanced for spaciousness or early 'Ping-Pong' type stereo recordings.
- iii. **60° Loudspeaker Angle:** This matrix simulates traditional 'textbook' loudspeaker placement in an equilateral triangle.
- iv. **90° Loudspeaker Angle:** This matrix simulates a wide loudspeaker placement favoured by some audiophiles. It may also be used to enhance recordings that lack spaciousness (some minimalist 'single point' recordings fall into this group).



*Note: When using the headphone outputs, the **XSpace** Holographic matrix for headphones is engaged. When using the line outputs (RCA/XLR), the XSpace Holographic matrix for loudspeakers is engaged.*

*It's true that traditional cross-feed tends to produce an 'out of head' sound, but with much diminished spatial components and a narrower soundstage, sometimes almost approaching mono. Most DSP based 3D designs produce an unnatural, echo-like sound, which may initially be impressive, but soon becomes tiring.*

*By contrast, **XSpace** Holographic for Headphones, provides not only 'out of head' placement of the sound sources, but renders the whole sound field in a manner that strongly parallels listening to loudspeakers in a normal room, all achieved without the added reverb.*

### **For Loudspeakers: (Line Outputs)**

The **XSpace** Holographic for Loudspeakers is an analogue matrix circuit that has two distinct functions. It

1. Corrects the fundamental spatial distortion in stereo recording
  2. Increases the width of the apparent soundstage beyond the width dictated by the loudspeaker placement
- i. **OFF:** **XSpace** Holographic is disabled (this allows the 'direct' sound to be judged).
  - ii. **30°:** This matrix corrects the spatial distortion caused by the recording/mixing/mastering process and restores the original width of the soundstage. This is the recommended default setting if the loudspeakers are already ideally placed for imaging.
  - iii. **60°:** This matrix corrects the spatial distortion caused by the recording/mixing/mastering process and adds an approximate **30°** to the apparent width of the soundstage. Thus, loudspeakers with narrow placement (e.g. loudspeakers closely located either side of a TV set) can offer a soundstage that extends beyond the left and right past the loudspeakers and is close to the ideal placement.
  - iv. **90°:** This matrix corrects the spatial distortion caused by the recording/mixing/mastering process and adds an approximate **60°** to the apparent width of the soundstage. This is close to the 'wide' placement preferred by some audiophiles.



The **XSpace** Holographic circuit for loudspeakers corrects a distortion of the **XSpace** sound field caused by recording via microphones and playback via loudspeakers. This sound field distortion was first described by Alan Dower Blumlein (the inventor of Stereophonic sound) and corrected by EMI in early 'Stereosonic' recordings.

However, the original Stereosonic circuit tended to result in a narrower soundstage than if recorded straight and often overcompensated distortion of the soundstage perspective. iFi's **XSpace** Holographic systems avoid this and instead, allow an expansion of the width of the sound stage.

*Tip:* These modes can also be used to enhance the imaging of recordings that offer poor spatiality.

## 14. Gain Selection

0dB (Default)/9dB/18dB.



*Tip:* Use the lowest gain possible for the best sound. At normal listening levels, the volume control should be around 12 o'clock. Increase the gain if the 12 o'clock position does not provide satisfying listening levels.

*Note:* Please be aware that the iCAN Phantom can output >14V in Single Ended mode and over 27V in Balanced mode. These levels are very high and can damage many headphones and/or drive most amplifiers (if used as a line-stage) into very hard clipping. Damage to headphones and/or loudspeakers may result from excessively high volume settings.



## 15. **XBass** adjustment

Different recordings and different headphones exhibit different frequency responses. **XBass** is an analogue signal processing (ASP) circuitry. It is sonically superior to Digital Signal Processing (DSP) systems. **XBass** is tailored to correct the bass deficiency in the headphone/loudspeaker and achieve the desired level. It is NOT a traditional tone or loudness control. The maximum boost is 12dB and the frequency at which this maximum boost is achieved is as follows:

**XBass OFF** is disabled (this allows the 'direct' sound to be enjoyed).

**XBass 10Hz** for headphones/loudspeakers missing only the very lowest bass (below 40Hz).

**XBass 20Hz** for headphones/loudspeakers missing some bass (below 80Hz).

**XBass 40Hz** for headphones/loudspeakers missing substantial bass including some mid-bass (below 160Hz).

*Note: Please be careful with the **XBass** settings especially at high gain and high volume control settings, as even the most power-hungry headphones may be damaged by the power of the iCAN Phantom.*

*Tip: The **XBass** circuit is designed to correct different levels of bass deficiency inherent in many headphones/loudspeakers. It is NOT a gimmick to add artificial bass to recordings. Great care has been taken in the design to ensure there is no degradation of sound quality.*

## 16. Stereo Balanced XLR Headphone Output

Connect XLR – 4 Pin Balanced headphones.

## 17. Analogue Volume control dial

To control the volume.

*Tip: For normal listening levels, the volume control should be between 10 and 2 o'clock. Adjust the gain upwards if the volume is unsatisfactory. If one cannot turn up the volume to even 10 o'clock (at the lowest gain setting), please connect the headphone to the iEMatch Balanced 4.4mm or Unbalanced 3.5mm or connections, which are matched to high-sensitivity headphones such as in-ear-monitors and other high-sensitivity modern headphones designed to operate from portable devices.*

## 18. Operating status LED

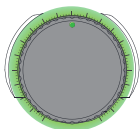

Warming-up  
(Green)

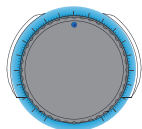

Solid-State  
(Blue)

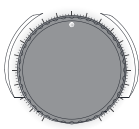

Tube  
(white)

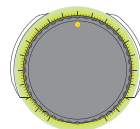

Tube+  
(Yellow)

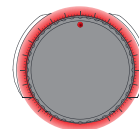

Protection  
(Red)

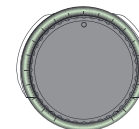

Mode switching  
(Flashing)

## 19. 19. Balanced 4.4mm Headphone Output

Connect balanced 4.4mm headphones.

*Tip: If possible, always use balanced headphones to take full advantage of the true balanced nature of the iCAN Phantom circuitry.*

## 20. Unbalanced 3.5mm Headphone Output

Connect 3.5 mm stereo headphones (compatible with unbalanced TRS and balanced TRRS configurations). This is a Unbalanced output.

## 21. Dual Damped Anti-Vibration Foot Post

Base support, please set the iCAN Phantom on a flat surface.

*Tip: The double layer damped anti-vibration footbed is specifically designed to provide the ultimate in vibration control. It consists of a double sandwich of a customised elastomer (silicone layer and a copolymer layer of ethylene and vinyl acetate) and a metal alloy (AL-Mg-Si aluminium alloy with hollow internal structure), allowing for minimisation of resonance in the iCAN Phantom chassis.*



## **22. Balanced XLR 3-Pin Signal Line Input**

Balanced XLR line input.

## **23. Unbalanced RCA 1-3 Signal Input**

Connect Unbalanced (S-E) input.

## **24. Bias Setting Memory Card Storage Back Cover**

Magnetically attached cover containing 6 memory cards for voltage bias settings from 500VDC to 640VDC.

This attachment can also be used to cover the front output panel when not in use or when the iCAN Phantom is used as a preamplifier.

*Tip: For information regarding the 6 memory cards please refer to item 5.*

## **25. Balanced XLR 3-Pin Line Output**

Balanced XLR line output. This output may be connected to an active speaker or balanced amplifier.

Please ensure the connected device does not connect pin 3 (negative phase signal) to ground.

## **26. Unbalanced RCA Line Output**

UnBalanced analogue signal output to an amplifier.

## **27. DC Power Supply Input**

DC 12V/4A - 15V/3A\* power input. Please connect iCAN Phantom to the enclosed power supply.

*Tip: Any 9v to 18v DC power source with a typical 25W ( maximum 75W) rating can be used with the iCAN Phantom (including vehicular, RV and boat based 12V DC power). The iCAN Phantom uses double-conversion power supplies that make it impervious to power supply noise and related problems. However, we strongly recommend the use of the included iPower Elite. It offers the latest in power supply technology and is better and cleaner than battery and aftermarket linear power supplies.*

## Quick Set-Up



Bias cards holder

Front cover

DC Power (12V-15V)



BAL XLR 3-Pin input

RCA 1-3 input

RCA output

BAL XLR 3-Pin output

# 1 Power

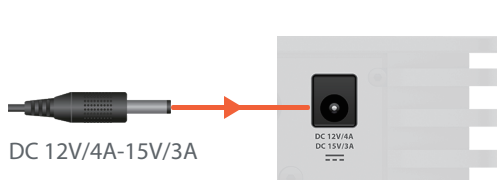

Press and wait for warm up (item 4)

# 2 Input

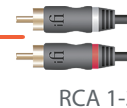
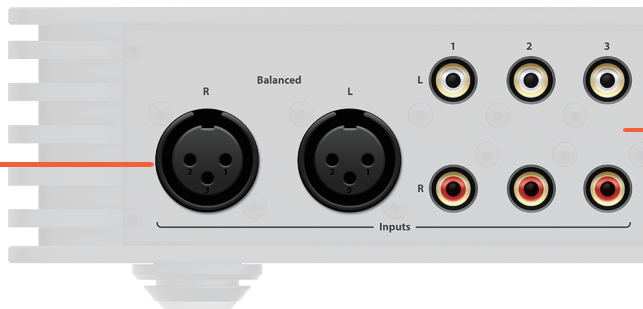

### 3 Analogue output



### 4 Headphones output - Standard

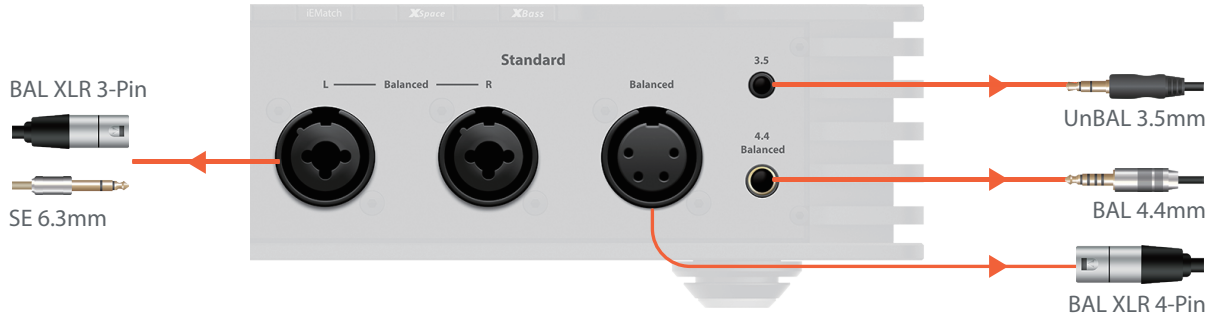



## 5 Headphones output - Electrostatic

### Normal

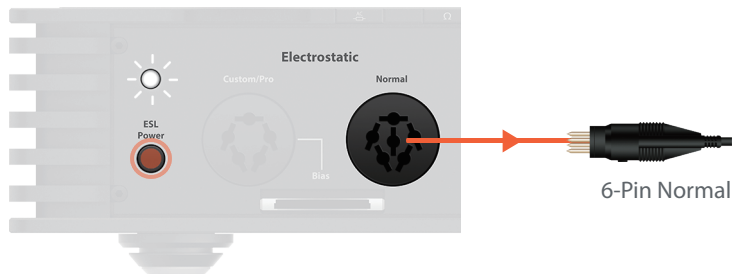

### Custom/Pro

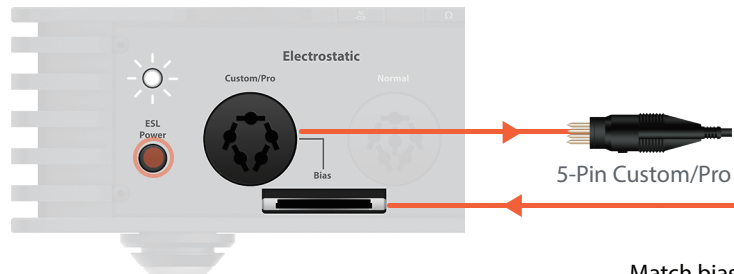

Match bias card to your headphones specification (item 5)



"iFi Nexis"



**Download the Nexis app for added features and future updates**

### **Set up your iCAN Phantom using our iFi Nexis App**

Please search for "iCAN Phantom" within the iFi Nexis app.

The iFi Nexis app helps you to use all the features and settings of the iCAN Phantom, such as OTA upgrades\*, remote control\*\* and more.

*\*OTA (Over the Air Technology), or Over the Air download technology, automatically downloads firmware upgrade packages and upgrades automatically over the network.*

*\*\*Provides users with a convenient and easy-to-use way to control their device, getting rid of the traditional remote control and adjusting all the functions and settings of the iCAN Phantom more easily, conveniently and freely.*



**Scan the QR code to view the official iFi audio iCAN Phantom video on YouTube.**

### **Cautions**

1. Avoid extreme heat, cold and humidity.
2. Avoid dropping or crushing the iCAN Phantom.
3. If you experience discomfort or pain, try lowering the volume or discontinuing use temporarily.
4. Always check the actual output volume on your earphone, headphone, or loudspeakers before playing audio, as many music player software and operating systems do not appropriately apply industrial standards governing volume control (e.g., USB Device Class Definition for Human Interface Devices). If in doubt, before playing any music, turn off CyberSync or any other volume synchronisation feature on the iFi Product and bring the volume down to the lowest setting.

### **Prolonged Heat Exposure**

Your iFi Product may become very warm during normal use. It is important to keep your iFi Product on a hard, stable, and well-ventilated work surface when in use or charging.

*Warning: To prevent possible hearing damage, do not listen at high volume levels for long periods.*



## Design Notes from the AMR/iFi Research & Development department

The iCAN Phantom circuit is fully-balanced with completely equal circuit sections for Positive (Hot) and Negative (Cold) signal phase of each channel. The volume control is a 6-way motorized ALPS type, 4 tracks are used to adjust the volume for the balanced signal, the other two are used for monitoring the volume control operation.

Maximum Output is > 27V in balanced mode, > 14V in unbalanced mode, maximum peak current is 1.4A for unBalanced Headphone connections and 0.7A for Balanced Headphone connections. The continuous output current is limited by protection circuitry that only engages in case of sustained overload. A short term sustained output of around 15,000mW is possible in Balanced operation.

The amplifier audio circuit is a development of iFi's revolutionary 'TubeState' design. It is fully discrete, fully balanced with either tube or JFET input switchable, bipolar transistor second stage and MOSFET-buffered bipolar class A power stage (with Class AB for low impedance headphones at very high levels). The resulting circuit may be best described as 'tri-brid' where each device is used to greatest sonic advantage while minimising any drawbacks. Furthermore, the circuit is DC-coupled to avoid using any sonically-degrading coupling capacitors.

Frequency response (0.5Hz -500kHz @ 0dB), noise (-142dB @ 0dB) and distortion (0.0008% @ 0dB) depend on gain and on which input device is selected. However (generally speaking), the levels of noise and distortion, especially in balanced operation challenge the limits of the Audio Precision test system.

The XLR and RCA outputs on the back offer full preamplifier function, but are not switched off if headphones are connected. Nonetheless, the iCAN Phantom should be used either as preamplifier or headphone amplifier, as generally a mixed use setup is not recommended.

The **XSpace** Holographic matrices are tightly integrated into the signal circuit. Not only is there no use of DSP and the linked AD/DA conversion, there are also no additional active elements.

If disabled, the passive elements (resistors, capacitors and inductors) that form the analogue matrix are completely removed from the circuit, so the fidelity of the signal in 'OFF' remains unaffected.

If enabled, the **XSpace** Holographic matrix fundamentally re-shapes the transfer function of the actual amplifying circuit to do its job. So again, the fidelity of the signal is as if the **XSpace** Holographic matrix was designed integral to the circuit. This is a highly-unusual design, as normally signal processing functions add extra circuits to the main amplification circuit. Such additional circuitry cannot but negatively impact sound quality when in use and often even when disabled.

## Notes on Electrostatic Headphones

Electrostatic headphones require very high voltages for operation. For example, Stax are around 101dB @ 100V, compared to around 105dB @ 1V for a common inefficient full size headphone. On top of that, they need a 'bias voltage,' usually 580V for modern Stax.

The iCAN Phantom offers both the original (normal) 230V Bias for 6-pin plug connected Stax headphones and adjustable bias from 500V to 640V (including a dedicated 580V setting for Stax Pro bias) for 5-Pin connected Stax electrostatic headphones. It can also accommodate many other manufacturers electrostatic headphones if adapters to Stax 5-Pin pro connection are used..

Different bias settings may be tried. Note that it will take a considerable time for the voltage to fall from a previous higher setting. Therefore, if testing different bias settings, it is best to start with the lowest setting and slowly work up towards the nominal voltage.

More bias produces a louder mid-range, while the bass remains at the original level. So lower bias may give a more warm sound, higher more bright.

Exceeding the rated bias for a given headphone may damage it, so it is not recommended and exceeding the rated bias is done at your own risk.

*Warning: AMR/iFi is not responsible for any damage arising from using the iCAN Phantom with incorrect settings.*



## Notes on Use with iCAN Phantom

Most electrostatic headphones are very inefficient. Due to the limited voltage handling and the low sensitivity, electrostatic headphones generally do not play very loudly, especially compared to traditional dynamic headphones.

Depending on the impedance control setting the iCAN Phantom can deliver between 320V RMS (910V PP) to 640V RMS (1820V PP).

These are very high voltage levels and may exceed the rated limit of the electrostatic headphones. Please confirm with your electrostatic headphone manufacturer what levels are allowed and, if in any doubt, only use the high impedance settings.

When using the iCAN Phantom, remember to keep the Gain, XBass and XSpace settings moderate. Gain is recommended at 9dB, XSpace only at the lower settings and the same for XBass, as otherwise the stress on both amplifier and headphone may be excessive.

Under the above conditions the volume on the iCAN Phantom should be able to be advanced to maximum (using an iFi DAC) without risk of protection circuitry engaging or damaging ANY electrostatic headphones as long as the impedance setting is 64 $\Omega$  or 96 $\Omega$ .

## Note on the design of the ESL section

In principle, an energiser for electrostatic headphones is a trivial challenge. All we need are a pair of transformers to create the very high signal voltages for the electrostatic headphones and some form of bias supply. Of course, what seems simple usually hides unexpected complexity.

For example, to make transformers that can turn 20V audio signals into a 640V signal, with low distortion, a flat frequency response and without obnoxious resonances is a serious challenge. Get it wrong and the sound will be coloured, something especially objectionable with the crystal-clear sound of electrostatic headphones.

In addition, while making a high voltage bias supply seems easy, we must remember that this bias voltage provides one part of the motive force that moves the diaphragm. Any noise on the bias supply will modulate the drive strength of the moving diaphragm and thus the sound. Obviously, this must be avoided.

Given the high voltages involved even trivial jobs like circuit board design become challenging as we must avoid any chance of these high voltages to get out of control. Therefore great amounts of spacing between voltage carrying traces and pins are needed, making a simple circuit board layout suddenly very challenging.

Then we need to make sure we can select multiple sources, with minimal impact on sound quality from the switches and good long term reliability, something that simple mechanical switches fail to deliver.

## The Transformers

In order to produce the high voltages requires by electrostatic headphones, the iCAN Phantom employs custom-made transformers of the highest quality

The extremely critical core of the transformers is a hybrid that combines ultra-thin GOSS with pinstripe permalloy lamination. A 100% GOSS core suffers from hysteresis at low levels causing distortion in quiet passages.



Meanwhile a 100% permalloy core cannot handle high levels without gross distortion. Combining the two materials makes sure each operates at its best. This reduces distortion dramatically, when compared to traditional cores, be they GOSS, amorphous iron or similar materials.

In order to combine a high step-up ratio with good behaviour without excessive resonances or bandwidth limitations, our custom transformers use a complicated multi-section winding with both vertical and horizontal sectioning. Extremely thin wire must be wound precisely and tightly to create the performance we required.

Combining this complex winding with an exceptional core produces a transformer that handles all levels without obvious distortion as well as offering a completely fiat frequency response without colorations well past the audio band.

Only with such an exceptional transformer can we approach and even exceed the best transformer-less amplifier in terms of performance.

### **The Bias System - Capacitive Battery Power Supply**

Commonly the bias voltage is created using the 50/60Hz mains power and a so-called Villard or Greinacher cascade rectifier (which is also sometimes called a Cockcroft-Walton voltage multiplier) is employed. This circuit can deliver very high voltages using rather generic and inexpensive components, but its operation is noisy.

Given the low frequencies of the AC used, large value capacitors tend to be needed, usually requiring rather nonlinear electrolytic capacitors, which have high leakage currents and so the cascade rectifier must operate constantly to keep the Bias Voltage from dropping.

At iFi we decided to completely toss out all existing solutions.



First, we decided to use a battery of multiple parallel film capacitors to provide the bias voltage. Film Capacitors hold their charge almost indefinitely. Given that isolation resistance of the electrostatic headphone is also very, very high, no current flows to discharge the capacitor bank. Therefore, if we charge the capacitor bank up to the nominal bias one time, we can simply leave the charged capacitor bank to “float” at the Bias Voltage.

In order to provide this one time charge we employ a very high frequency switching system (appx. 750kHz). This system uses a tiny, fully shielded transformer and exotic ultra-fast high voltage rectifiers. More crucially, this system shuts down completely as soon as the correct bias voltage has been established in the capacitor bank.

As some minor discharge happens even through air, we do need to top up the capacitor bank every 30 second or so. This process usually takes a few millionth of a second (microseconds) as usually one or two switching cycles suffices to replenish the lost charge. Then the switching system is again off completely.

Any noise that this system creates is confined to medium frequency radio bands for the infrequent short durations during which it is active. For over 99.999% of the time the charging circuit is completely off.

The result is in effect a perfect high voltage battery to provide the bias for the electrostatic headphones. Two completely separate and independent bias circuits are employed, one for the 230V “normal” bias and another adjustable, to cover a wide range of modern electrostatic headphones.

## The Signal Routing

The entire signal switching for the input selection utilises gold-plated silver contact miniature relays filled with an inert gas. This makes sure the contacts will remain like new for a long time to come.

The loudspeaker connections are switched using sealed silver alloy contact relays for minimum impact on the sound quality of the loudspeaker path.



## DISCLAIMER

*This material mentions various third-party trademarks solely to indicate compatibility and for identification purposes. All trademarks and logos are the property of their respective holders. Use of them does not imply any affiliation or endorsement by them. This information is provided "as is" with no warranties, and use of it is at the user's own risk.*

## Specifications:

<b>Gain :</b>	0dB, 9dB and 18dB user-selectable	
<b>Frequency Response:</b>	0.5Hz to 500kHz(-3dB)	
<b>THD &amp; N:</b>	<b>Balanced</b>	<b>unBalanced</b>
Solid-State	≤0.0015%	≤0.007%
Tube	≤0.002%	≤0.006%
Tube+	≤0.012%	≤0.2%
<b>SNR:</b>	>145dB(A)	> 130dB(A)
<b>Output Power:</b>	>15,000mW (@ 16Ω)	>5,760mW (@ 16Ω)
<b>Output Voltage:</b>	>27V (@ 600Ω)	>14V (@ 600Ω)
<b>Input voltage:</b>	DC 12V/4A or 15V/3A (iCAN Phantom)	
<b>Input voltage:</b>	AC 85 – 265V, 50/60Hz (iPower Elite)	
<b>Power consumption:</b>	< 27W idle, 75W max.	
<b>Dimensions:</b>	256 x 185 x 120 mm (10.1" x 7.3" x 4.7")	
<b>Net weight:</b>	4.2 kg (9.3 lbs)	
<b>Limited Warranty:</b>	12 months	

\*12 months typical or as permitted/required by local reseller laws.

\*\*Specifications are subject to change without notice.

**Test conditions:** Gain = 0dB, 0.775V(0dBu) with 300 Ohm load unless stated otherwise

SNR Balanced re 27V, SNR SE re. 14V



ifi