

iBasso Audio

OX150

High Performance Digital Audio Player

In Pursuit of Perfection

# Contents

Package components ..... 1–2

Main Features ..... 3–4

Specifications ..... 5–7

Names of Parts & Functions ..... 8–12

Basic Operation ..... 13–14

Power on/off, Power on/off the screen,  
Reset, Charging, USB–DAC function

Android Basic Features ..... 15–21

Introduction

WiFi Connection, Application Installation,  
App, to uninstall, USB Connections, Firmware update,  
Power off

# Package components

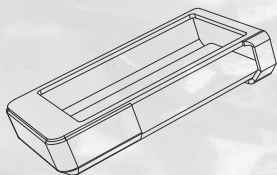

Protective Case



Warranty Card



DX150 Player



Type-C Cable



Balanced Burn-in Cable



Coaxial Cable



### **DX150 Player:**

DX150 High Performance Digital Audio Player.

### **Protective Case:**

Use the protective case to protect the DX150's chassis from scratches.

### **Quick Start Guide:**

This reviews the basic functions of the DX150.

### **Warranty card:**

The warranty will be requested at the time of warranty repair. Please retain the warranty card.

### **Type-C cable:**

Connect the Type-C cable to a computer for Charging, data transfer, and USB-DAC function.

### **Balanced Burn-in cable:**

Plug the burn-in cable into the BAL out socket, and keep playing music to burn-in the DX150. The burn-in process helps the DX150's sound reach its full potential by forming the capacitors and stabilizing the electronic components used.

### **Coaxial cable:**

Connect the coaxial cable to an external DAC, to allow the DX150 working as a digital transport.

# Main Features

- Dual AK4490EQ DAC Chips.
- Bit for Bit Playback Support up to 32bit/384 kHz.
- Support of Native DSD up to 256x.
- XMOS USB Receiver with Thesycon USB Audio Driver, Easy to use USB DAC.
- Full Synchronization Technology with TCXO and PLL.
- 4.2” IPS Screen (768\*1280) with Capacitive Touch Panel, Bonded by OCA.
- Mini Optical Output and Mini Coaxial Output.
- 8-core CPU.
- 2GB LPDDR3.
- 32G of Internal Memory.
- 2.4G/ 5G WiFi and Bluetooth 4.1.



- Patented User Exchangeable AMP Card.
- Three Physical Buttons (Previous, Play/Pause, Next)
- 150–Steps Digital Volume Control.
- Audio Formats Supported: APE, FLAC, WAV, WMA, AAC, ALAC, AIFF, OGG, MP3, DFF, DSF, DXD.
- Support for M3U Playlist
- 4400mAh 3.8V Li–Polymer battery (Play time varies with AMP card)

# Specifications

**OS:** Android 6.0

**CPU:** 64bit 8 Cores A53

**RAM:** 2G LPDDR3

**Rom:** 32G eMMC

**DAC:** Dual AK4490EQ

**Sample Rate:**

PCM: 8kHz–384kHz(8/16/24/32bits) native

DSD: DSD64/128/256

**System Clock:** Fully Synchronization

Technology with TXCO and PLL

**Screen:** 4.2inch 768\*1280 Retina Display

**Micro SD:** Supports SDHC & SDXC, up to 2TB

**USB DAC Function:** XMOS XU208, Thesycon

USB driver

**WiFi/Bluetooth:**

802.11(b/g/n/ac)(2.4Ghz/5Ghz), Bluetooth 4.1





**Battery:** 3.8V 4400mAh Li-polymer battery  
manufactured by MBELL

**Quick Charge:** PD 2.0, compatible with QC 2.0

**Size:** 128.5mm\*69mm\*19.5mm  
(5inch\*2.7inch\*0.77inch)

**Weight:** 245g (8.65oz)



## 2.5mm Balanced Output:

Output Voltage: 4.8Vrms(without load)3.7Vrms(32Ω load),  
425mW THD+N<0.001%)

Frequency Response: 10Hz–40KHz +/-0.5dB

THD+N: 0.00028%, -111dB (without load @2.4Vrms)

0.00032%, -110dB (32Ω load @2.4Vrms)

Dynamic Range: 118dB

S/N: 118dB

Crosstalk: -119dB

## 3.5mm Single Ended Output:

Output Voltage: 2.4Vrms (without load)

2.4Vrms (32Ω load) , 185mW THD+N<0.001%)

Frequency Response: 10Hz–40KHz +/-0.5dB

THD+N: 0.0004%, -108dB (without load @1.2Vrms)

0.0004%, -108dB (32Ω load @1.2Vrms)

Dynamic Range: 117dB

S/N: 117dB

Crosstalk: -115dB

## Line out:

Output Voltage: 2.4Vrms

Frequency Response: 10Hz–40KHz +/-0.5dB

THD+N: 0.0004%, -108dB (without load @1.5Vrms)

Dynamic Range: 118dB

S/N: 117dB

Average Play Time: 10.5 hours with the DX150

The play time varies with different sample rate/bit rates,  
and headphone/IEM load.

# Names of Parts & Functions





### **a. Power:**

Short Press—Power the LCD screen on and off.  
Long Press—To display the pop up window with three options that are Power off, Reboot, and To Mango.

### **b. Volume Control Wheel:**

Rotate the wheel upward to increase the volume.  
Rotate the wheel downward to decrease the volume.

### **c. Next/Fast Forward:**

Short Press – Play the next track.  
Long Press – Fast forward.

### **d. Play/Pause:**

Short Press – Play/Pause.  
On the Mango OS, long press the play button to lock the screen.

### **e. Previous/Rewind:**

Short Press – Replay previous track.  
Long Press – Rewind.

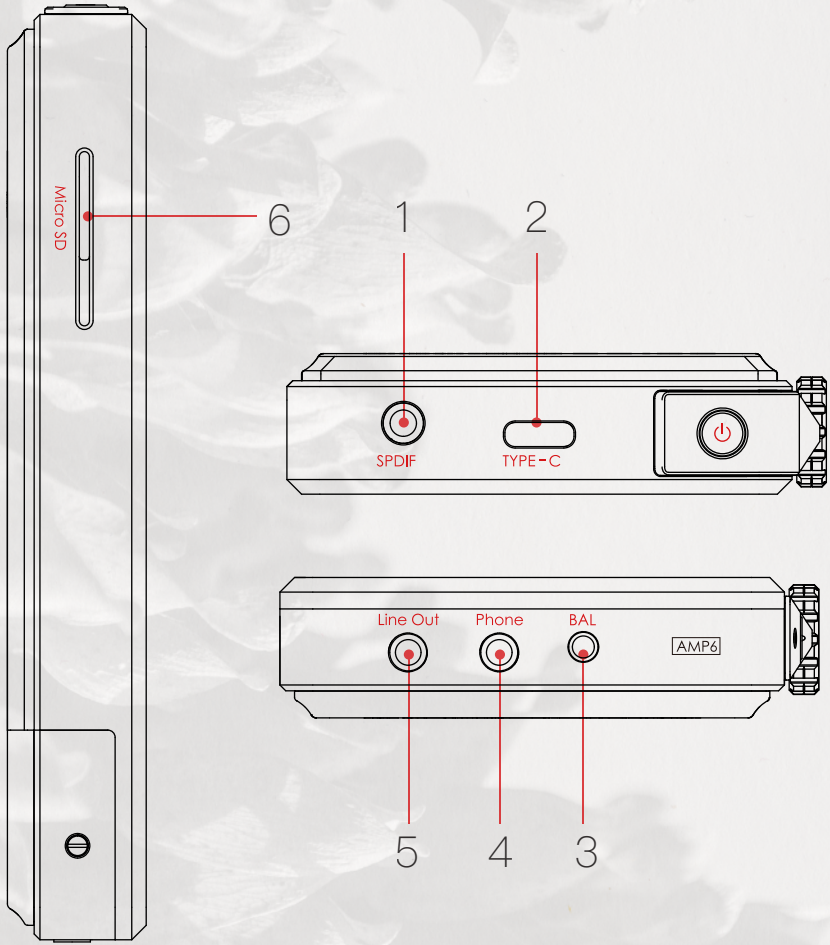



## **1. Mini Optical/Coaxial Output Port:**

Use a mini optical cable or the furnished coaxial cable to play music stored in the DX150 on an external device with a coaxial input port or an optical input port.

Mini optical/coaxial output has the highest output priority which would close the phone out or line out when optical/coaxial cable plugged in.

## **2. Type-C Port:**

Connect the DX150 to a computer or a USB charger to charge the DX150.

Connect the DX150 to a computer to allow the DX150 to work as a card reader.

Connect the DX150 to an OTG storage device to play music files.

Connect the DX150 to a PC or a Mac computer to work as a USB DAC.

## **3. Balanced Phone Port:**

Plug in the 2.5mm balanced earphone and output sound through the Balanced phone port.

#### **4. Phone Port:**

Plug in the single-ended earphone and output sound through the phone port.

#### **5. Line Out Port:**

Use a 3.5 to 3.5 interconnect cable to play music stored in the DX150 on an external amplifier with a line in port.

#### **6. Micro SD Card Slot:**

Insert a Micro SD card into the DX150 to access its stored files.

The following screen pops up after Micro SD card inserted.

**Scan SD Card:** Press “YES” to fully scan the Micro SD card.

**Browse Files:** Press “ NO ” to skip media scanning, and browse the Micro SD card in folder structure.



# Basic Operation

## **Power on/off:**

1. Press and hold the power button to power on.
2. After the DX150 is powered on, a long press of the Power button to display the pop up window, press Power Off button to power off the DX150.

## **Power on/off the screen:**

Single press the power button to power on/off the screen after the DX150 was powered on.

## **Reset:**

When the DX150 stop unexpectedly during operation and the keys are no longer responsive,press and hold the power button for 10 seconds to reset the DX150.

## **Charging:**

The DX150 can be charged by computer through the USB port or any USB charger with 5V output voltage and 1 A or above output current.

A full charge takes about 3 hours with 5V 2A USB AC adapter, when the DX150 is powered off.

## **Connecting to a computer to work as a USB DAC:**

The DX150 can work as a USB DAC for Windows PC, Mac computer, and Linux computer.

It is driver free on Mac computer and Linux computer. For Windows PC, one can download the driver from [iBasso.com](http://iBasso.com) and install it following the steps, before using the USB DAC function.

The DX150 supports up to 32bit/384kHz PCM, and native DSD up to 256x when be used as a USB-DAC.

### **The following is the instruction:**

1. Power on the DX150.
2. Press the DAC on button on Settings/DAC.
3. The “USB DAC” screen will be shown on the DX150.
4. Connect the DX150 to a computer via the furnished type-C Cable.
5. Select “iBasso Audio HiFi device” as the audio output device. Then one can play music on the computer and listen it via the DX150.



# Android Basic Features introduction

## WiFi Connection:

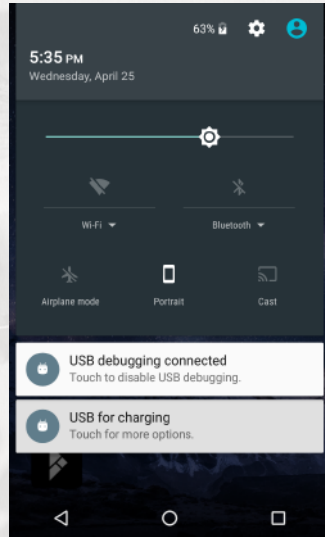
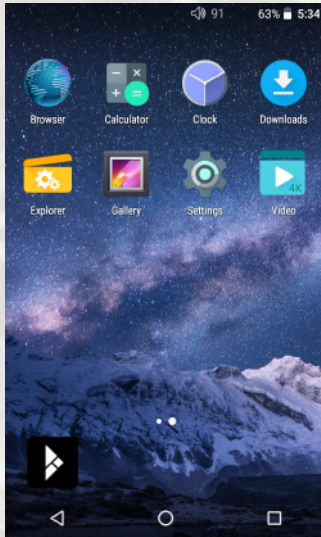

- ① On the Android desktop, from the top, swipe down the screen to display the notification bar.
- ② Press the Wireless local area network (WLAN) to turn on the WiFi function. The first time you enter the WLAN , you need to choose the hot spot you will be using and enter the password. From this point forward your password for this hotspot will be remembered and you simply press the WLAN icon to connect to the WiFi internet.

# Application (APP) Installation:

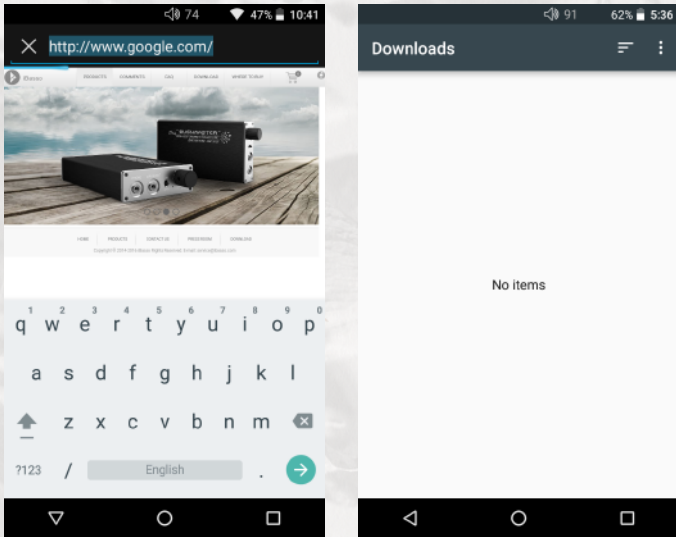

- ① Press the internet browser on the desktop.
- ② Enter the website address of the APP.
- ③ Find the download icon on the website and start the download.
- ④ Return to the desktop and open the download manager.
- ⑤ Press the downloaded app and install it.



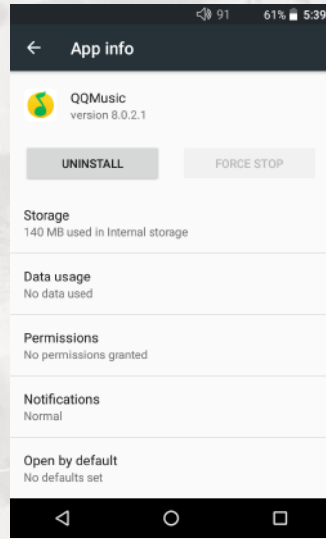
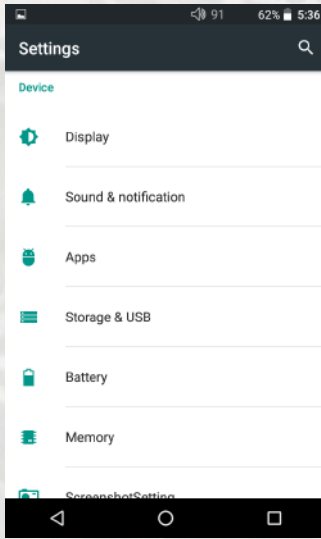

## App, to uninstall:

- ① Press the Settings icon on the desktop and scroll down and press APPS.
- ② Press the APP that you would like to uninstall.
- ③ Press uninstall to delete the APP.

## USB Connections:

- ① Connect the DX150 to a computer using the furnished type-C cable.
- ② Swipe down the screen from the top to display the notification bar.
- ③ Press the USB connection icon to choose the type of USB use.

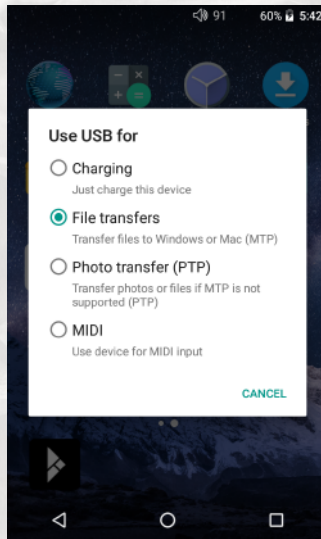

**Charging:** The DX150 can be charged by a USB quick charger, computer through the USB port, or any USB charger with 5V output voltage and 1A or more output current.



A full charge takes about 2 hours with a quick charger and 3 hours with a 5V 2A USB AC adapter. These charging times are based on when the DX150 is off and charging.

**File Transfers:** Transfer files to Windows or Mac (MTP).

**Photo Transfer (PTP):** transfer photos or files if MTP is not supported.

**MIDI:** Use device for MIDI input.

## Firmware Update:

- ① Load the firmware update file (ota.zip) onto a SD card's root folder.
- ② On the Android desktop, press Settings → About DX150 → System updates → local update → default and tap the zip file.
- ③ Press update button to start the update.

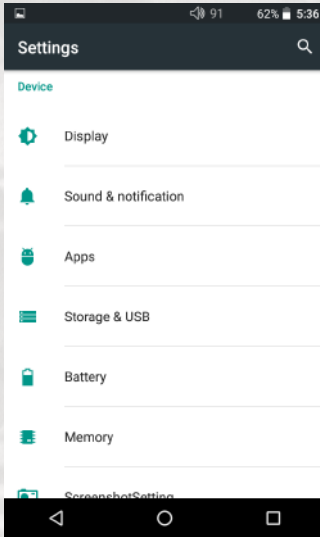

④ The whole update will take about 10 minutes. Reboot the DX150 after update completed.

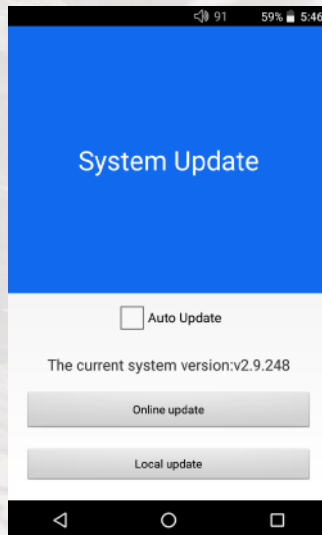



## Power off, Reboot:

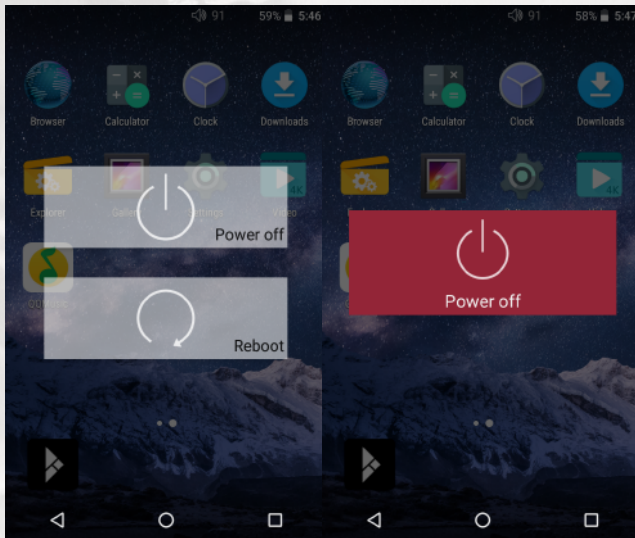

- ① Long press the power button for 3 seconds.
- ② There is a pop up window with two options.
- ③ When Power off is selected, the DX150 will be powered off.
- ④ When Reboot is selected, the DX150 will reboot.



**iBasso Audio**  
In Pursuit of Perfection