

LYNGDORF AUDIO MP-60

OWNER'S MANUAL

Table of Contents

Compliance	4
Introduction	5
Pre-Installation	6
Unpacking the Product	6
Home Automation System Integration	7
Preparing for Mounting in a Rack	7
Rear Panel	8
Remote Control	9
How to Pair Remote Control in RF Mode	10
Switching Remote Between RF and IR Mode	10
Getting Started (details in following chapters)	10
Installation Via Installer Menu	11
Installation Via Web Interface	11
Home Screen	11
Setup	13
Source Setup	13
Speakers and Room	15
Verify Speakers	20
Adjust Sub	20
Channel Gain	20
RoomPerfect™	21
How to Set Up RoomPerfect™	21
RoomPerfect™ Preparations	22
Measuring the Focus Position	23
Measuring Random Room Positions	23
System Configuration	26
General Setup	26
Trigger Setup	27
Network Setup	28
Streaming Setup	30

Streaming Playback	30
Video Setup	33
Video Output	33
Video Input	34
Zone B Setup.....	35
Audio Setup	35
Audio Processing	35
Voicing Setup	35
Manage Software.....	36
Download system log	36
Backup	36
Restore.....	36
Factory Reset.....	36
Update Software	37
Troubleshooting	38
RoomPerfect™	38
Error Messages.....	38
Trademarks.....	41
Service Information.....	41

Compliance

WEEE

The European Parliament and the Council of the European Union have issued the Waste Electrical and Electronic Equipment Directive. The purpose of the Directive is to prevent waste of electrical and electronic equipment and to promote reuse, recycling, and other forms of waste recovery. Lyngdorf products and the accessories packed with them are subject to the WEEE Directive. Please dispose of any waste materials in accordance with your local recycling regulations. Products and equipment which must be collected for reuse, recycling, and other forms of recovery are marked with the icon of the crossed-out waste receptacle.



FCC

Lyngdorf products and accessories comply with parts 15 and 68 of the FCC rules. Operation is subject to the following two conditions: (1) this device may not cause harmful interference; and (2) this device must accept any interference received, including any interference that may cause undesired operation.

Changes or modifications not expressly approved by the party responsible for compliance could void the user's authority to operate the equipment. Equipment marketed to a consumer must be capable of complying with the necessary regulations in the configuration in which the equipment is marketed.

Introduction

The MP-60 is an advanced Surround Sound, Preamplifier / Processor with full support of the latest Dolby® Atmos, DTS:X PRO (available spring 202) and Auro-3D® surround sound formats. The processor can decode 16 discrete channels from the source and features 16 balanced XLR outputs for the discrete channels or additional subwoofer outputs. Whatever your setup is, the MP-60 will provide the optimal performance due to its bass-management and room correction system, RoomPerfect™.

Both Dolby, DTS and Auro provides modes for processing legacy surround formats or for upmixing the sound into all your speakers. This is referred to as POST PROCESSING, and it can be set on a Source or controlled from your remote control.

The MP-60 will support any setup from the simplest STEREO setup to the most advanced 3D surround setup, and we have made great efforts for having a simple user interface, where all settings are displayed and arranged for easy installation.

Optional modules will allow for digital integration with the most advanced media sources and/or digital distribution of the output signals (Ref.: AES3 or AES67 formats).

Please read through this manual for understanding the functions available – or as later reference.

- The latest version of this manual is available for download from www.lyngdorf.com

Enjoy !

Pre-Installation

Please read all material carefully prior to installation. If you need additional assistance, contact your Lyngdorf Audio representative or visit Lyngdorf.com.

Unpacking the Product

Carefully remove the unit and accessory kit from the carton and check for shipping damage. Contact the shipper and your Lyngdorf Audio representative immediately if the unit bears any sign of damage.

Note: Keep the shipping carton and all packing material for future use. If this unit is shipped for service without the original packing, damage could occur and void the warranty.

Inventory

Check the list below to ensure that all necessary product components have been delivered. Report all discrepancies to your Lyngdorf Audio representative immediately.

- Owner's manual
- Power cord
- Remote
- Microphone
- Microphone stand
- Microphone cable
- Rack ears

Operating Voltage

Lyngdorf Audio products must be connected to the mains power system only. The MP-60 will automatically detect voltages between 100-240V.

Ventilation Requirements

The MP-60 does not have a built-in fan, nor does it require special measures to ensure proper heat dissipation. It should be placed according to these guidelines:

- It should always have at least one inch / 25mm of free space on all sides.
- It should be placed in an environment free of excessive heat.
- In a rack system, the MP-60 should be placed at the bottom of the rack, still with at least one inch / 25mm free space on top and sides.

Home Automation System Integration

The MP-60 is compatible with home automation systems via the RS232 and network connector on the rear socket panel. The MP-60's IR and trigger connections can also be programmed for use in a home automation system.

IP Control

Connect the MP-60 to your local network and access the MP-60 by going to <http://mp60.local> in your browser.

Pressing the OK button on the remote and toggling through the information, you will see the IP address allocated to the MP-60.

Open a TCP connection on port 84 and use the same protocol as on the serial interface. Use Telnet, Putty, or a similar program to open the TCP connection.

If you do not know the IP address of the MP-60 on your local network, the MP-60 supports Apple's Bonjour Discovery service, which must be on the computer with which you wish to set up the MP-60. The software is built-in as part of the Apple OS X operating system (not iOS devices). For Windows operating systems, the software can be found at <http://www.apple.com/support/bonjour/>

Preparing for Mounting in a Rack

The MP-60 processor is equipped from the factory with feet for free-standing placement.

To install the MP-60 in a rack:

1. Turn the MP-60 upside-down and place it on a stable, even surface.
2. The screws used to fasten the rack brackets to the bottom of the MP-60 are in the holes designated for the brackets when the product leaves the factory.
3. Fasten the brackets for rack mounting to the MP-60.
4. If so required, the feet can be removed
5. Mount the MP-60 in a rack.

Note: A rack mount kit is available for achieving a cleaner 4U rack-size (item # 900008201)



Rear Panel

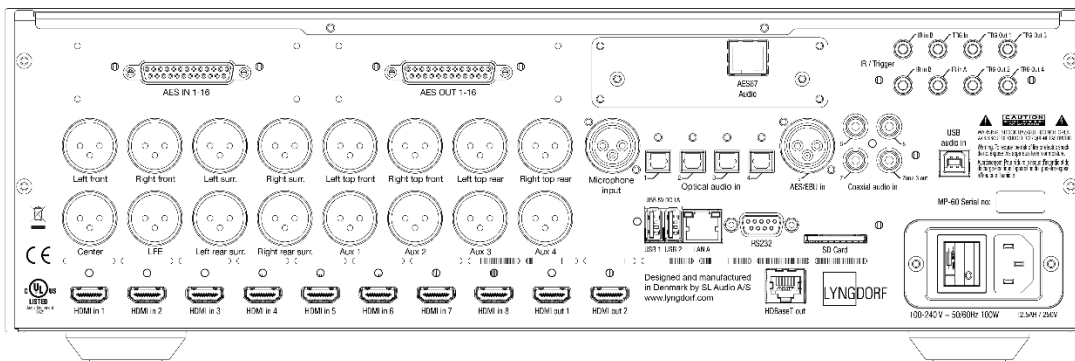

On the back of the MP-60, you will find a range of inputs and outputs:

- 16 x XLR, Differential balanced audio outputs (configured for 7.1.4 plus 4 auxiliary)
- 8 x HDMI inputs and 2 x HDMI outputs, all 4K / 18 Gbps compatible. eARC on HDMI OUT 1
- 1 x HDBaseT™ output
- 2 x USB A connectors, for music file playback, backup, software updating, etc.
- 1 x Streaming USB B audio input
- 1 x RJ45 Network connector (LAN/Ethernet)
- 1 x Microphone input for the RoomPerfect™ room correction microphone
- 1 x SD card slot for storing backup data
- 3 x Inputs from external IR receivers (IR remote control)
- 1 x Trigger input and 4 x trigger outputs
- 1 x RS-232 connector for serial control of the unit
- 1 x DB-25 16 channel DCI-compliant AES3 digital input (optional upgrade)
- 1 x DB-25 16 channel DCI-compliant AES3 digital output (optional upgrade)
- 1 x RJ45 16 channel AES67-compliant digital input/output (optional upgrade)
- 4 x Optical, 1 x AES/EBU and 3 coaxial digital audio inputs
- 1 x Coaxial digital audio output – stereo for Zone B (ref.: Zone 3)

Notes: HDBaseT™ is a standard for having up to 100 meter / 300 feet cable to your television or projector. Using optical HDMI cables will require using a USB connection for power supply, as the HDMI connector provides max. 5V/50mA.

Differential balanced output connection means that PIN 1 is Shield/Ground, PIN2 holds audio signal and PIN 3 holds an inverted audio signal. If your power amplifier requires a single ended (RCA) connection, you must ensure that the PIN 3 is disconnected (lifted). PIN 3 in the MP-60 connector may not be connected to ground.

Remote Control

The MP-60 comes with a dedicated remote control, which can operate both with radio frequencies (RF) and infrared control (IR)

Setup	Access the installation menu.
Standby	Turn the MP-60 on and into standby.
Audio	Access the post-processing menu.
Trim	Access to miscellaneous audio adjustments.
Up/Down	Move up and down in menus. Browse available settings in a menu. Toggles between the available RoomPerfect™ filters.
Left/Right	Move left and right in menus. Toggle between neutral and the available voicings.
OK	Activate the info screen, indicating the status of the unit. Select a menu and store a selected setting.
Back	Return to the previous menu.
Menu	Access the user menu.
SRC	Access the source menu list.
Source +/-	Toggle between active sources.
Volume +/-	Turn volume up and down.
Mute	Mute and restore the sound.
Play/Pause	Play/pause the currently playing track in the media player.
Skip Forward/Backwards	Skip in the current playlist in the media player.



How to Pair Remote Control in RF Mode

The MP-60 remote has both an IR and RF mode, and is by default set to IR.

To pair the RF remote control to the MP-60:

1. Turn on the MP-60.
2. Hold down Play/Pause and OK until the remote control's green LED flashes.
3. Release the buttons.
4. Point the remote control at the MP-60 and hold it within 30cm / 1 foot of the front panel; when the green LED stops blinking, the remote is connected.
5. The remote is now RF paired to the MP-60.

To reset the pairing of the remote control, press Back and OK until the red LED flashes twice.

Switching Remote Between RF and IR Mode

To switch the remote from IR to RF mode, hold down OK and 2. The LED will flash green twice.

To switch the remote from RF to IR mode, hold down OK and 1. The LED will flash red twice.

If you press a button on the remote and the red LED at the top turns on, then you are in IR mode. If it turns green you are in RF mode.

Getting Started (details in following chapters)

Setting up the MP-60 surround sound processor requires either a network connection or a HDMI connection to a screen by following these steps:

1. Connect the speakers to the power amplifiers.
2. Connect all external equipment, audio & video, home automation system, mains power, etc. to the MP-60.
3. Switch on the MP-60 mains connector on the back and all connected equipment.
4. Turn on the MP-60
5. Access the setup menu via the web interface or press Setup on the remote for having the Menu on the connected screen.
6. Go to "Speaker and Room" and set the parameters for your speakers.
7. Connect the amplifiers to the correct outputs now specified in the menu
8. Select and press "Verify speakers" to check that speakers and amplifiers are correctly connected.
9. Adjust level(s) on your subwoofer(s) through the feature in the menu, 'Adjust Sub'.
10. Measure and enter the distances to all speakers
11. Run the RoomPerfect™ Guided Setup.
12. Set up sources, audio preferences, stand-by state, zone b, etc.
13. Save and make a backup of the calibration and settings.

Installation Via Installer Menu

Connect a screen to the MP-60 using any of the video output sockets on the back. Access the menu system by pressing the Setup button on the remote control.

There are some differences between how the web interface and the Installer Menu. This manual describes how to set up via the installer Menu interface.

Installation Via Web Interface

You will need a computer, and the MP-60 must be connected to a router of an existing network.

If you do not know the IP address of the MP-60 on your local network, the MP-60 supports Apple's Bonjour Discovery service, which must be on the computer with which you wish to set up the MP-60. The software is included in the Apple MAC OS operating system (not iOS devices). For Windows operating systems, the software can be found at <http://www.apple.com/support/bonjour/>

- Access the web menu by typing <http://mp60.local/> in your browser.
- Or, press the OK button on the remote. Toggling through will display the IP address.
- Or, download the Lyngdorf Remote application. Under settings find the MP-60 connected to the same network as the mobile device and select 'Open Device in browser'.

Home Screen

The HOME screen refers to the daily operation as performed with the remote control and displays selected input and formats. This page shows information as to audio and video inputs and formats, and you can control the volume level or Mute the sound. These settings will be reset to default values, when the MP-60 is turned into stand-by mode.

You can switch between Sources, change Voicings, RoomPerfect™ focus point Post Processing as well as activating Loudness function and adjusting Lip-sync.

Post Processing allows you to choose between following tools:

- Dolby Upmixer / Up-mixes all type of signals to use all existing speakers using Dolby's techniques.
- Neural:X / Up-mixes all type of signals to use all existing speakers using DTS' techniques.
- Auro-3D Automatic / Decodes Auro 3D signals and up-mix all type of signals to use all existing speakers using Auro's techniques.
- Auro-2D / Up-mixes stereo signals to use surround sound speakers using Auro's techniques.
- Auro-Stereo / Downmix of multi-channel signals to stereo using Auro's techniques.

- Auro-Native / Decoding of 2D Auro formats – other signals are passed through
- Virtual:X / Creates a virtual surround sound effect from a stereo setup
- Stereo / Downmix of multi-channel signals to stereo.
- Party / Distributes a full-range signal to all channels

Loudness management turns on 'Late Night' functions dedicated to the specific formats being decoded. These functions are managed individually in the setup menu: Audio Setup / Audio Processing.

Lip-sync settings will delay the sound processing in order to have correct synchronization with the screen images. With a general audio offset, you should adjust the lip-sync on the specific Source settings in the Setup menu.

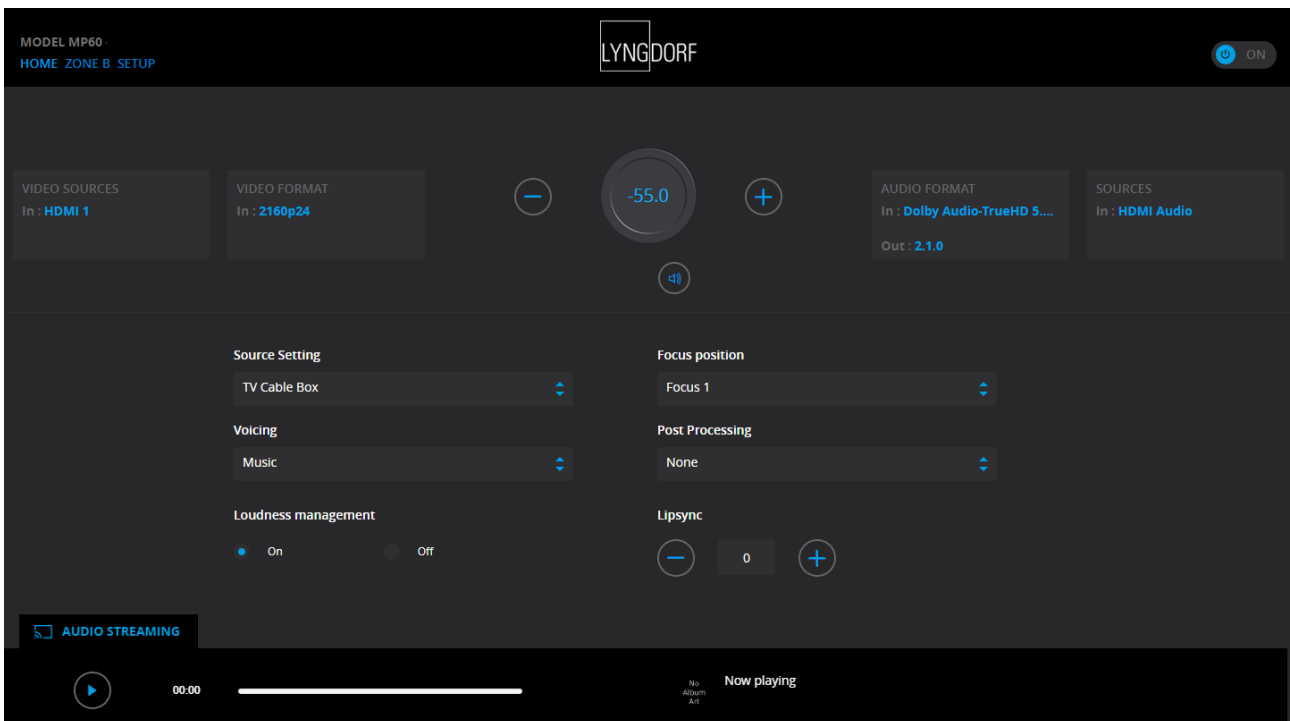

The interface for controlling the built-in media streamer is found in the bottom section of this page. For information as to the use of the interface see section for Streaming Setup.

Setup

The SETUP screen refers to all basic settings and option in the installation of the processor.

Source Setup

In the Source menu, you will find a list related to the input connectors. This register is though very flexible as a Source can be specified to use individual inputs for audio and video. This means that several sources can relate to the same input connectors – and vary in relation to the content, like ‘Action Movie’ and ‘Music Video’ being identical in connections, but differ in Post Processing setting, Voicing filter and trigger action.

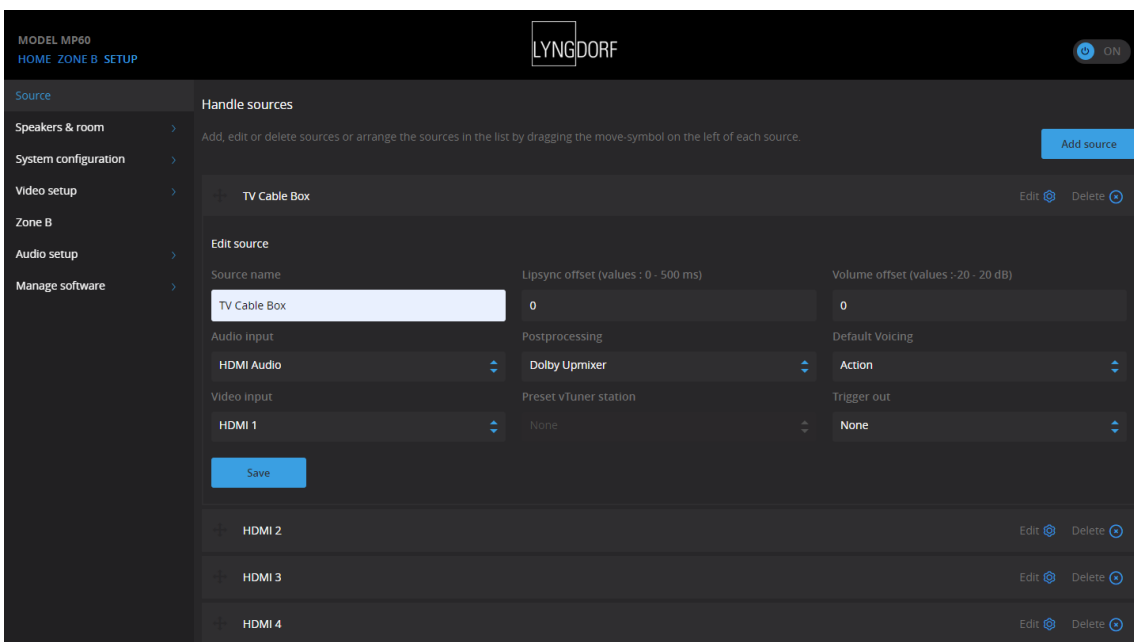

Add / Edit Source

Source name

Input your personal reference for the source.

Lipsync offset (ms)

Set delay time in milliseconds to ensure that the video and audio signals are played back simultaneously.

Volume offset (dB)

Enables you to match input levels from different sources.

Audio input

Select the audio input connector. If you want the audio input to match the video input from an HDMI source, select HDMI Audio. If you want to create a Source using the built-in radio player, you should choose Internal Player, which will activate the selection of Preset vTuner stations.

Default postprocessing

Select the postprocessing mode, which is found most suitable for content on this Source

Default voicing

Select the voicing for this source, which is found most suitable for content on this Source

Video input

Select the input connection for this Source

Trigger out

Choose which trigger output to activate when using this Source. (The interface for controlling the triggers is found in the Trigger Setup under System Configuration)

Preset vTuner station

Selects stored presets of the vTuner Internet radio station. (The interface for controlling the built-in media streamer with vTuner is found in the bottom section of the HOME page)

To save changes, you must press "SAVE" after making changes to each source. Do not go to the next input before saving changes.

Arrange Sources

Change the order through Screen Setup menu by:

- Highlighting it
- Moving it out of the stack by pressing right on the remote
- Moving the source by pressing up/down
- Reinserting it by pressing left.

Change the order through website menu by:

- Grab the  symbols with the mouse and move this source to the desired position

Delete Source

Delete an enabled source through Screen Setup by highlighting it and pressing right on the remote.

In the web menu press Delete button.

Speakers and Room

You need to configure the MP-60 according to your speaker setup, setting the sizes of the speakers, so that the Bass Management function can optimize the overall performance. In the setup page the connectors will be highlighted with information as to signal type.

The purpose of the speaker setup is to tell the system which speakers and subwoofers are available and how big the speakers are, which in turn reveals how much bass the speakers are capable of reproducing (Bass cut-off frequency). The bass for each speaker channel is directed to the optimal output.

References to “speakers” in this document are specific to satellite or full-range speakers and do not include subwoofers.

Speaker setup

As factory default the MP-60 is displaying a 7.1 speaker configuration as shown below:

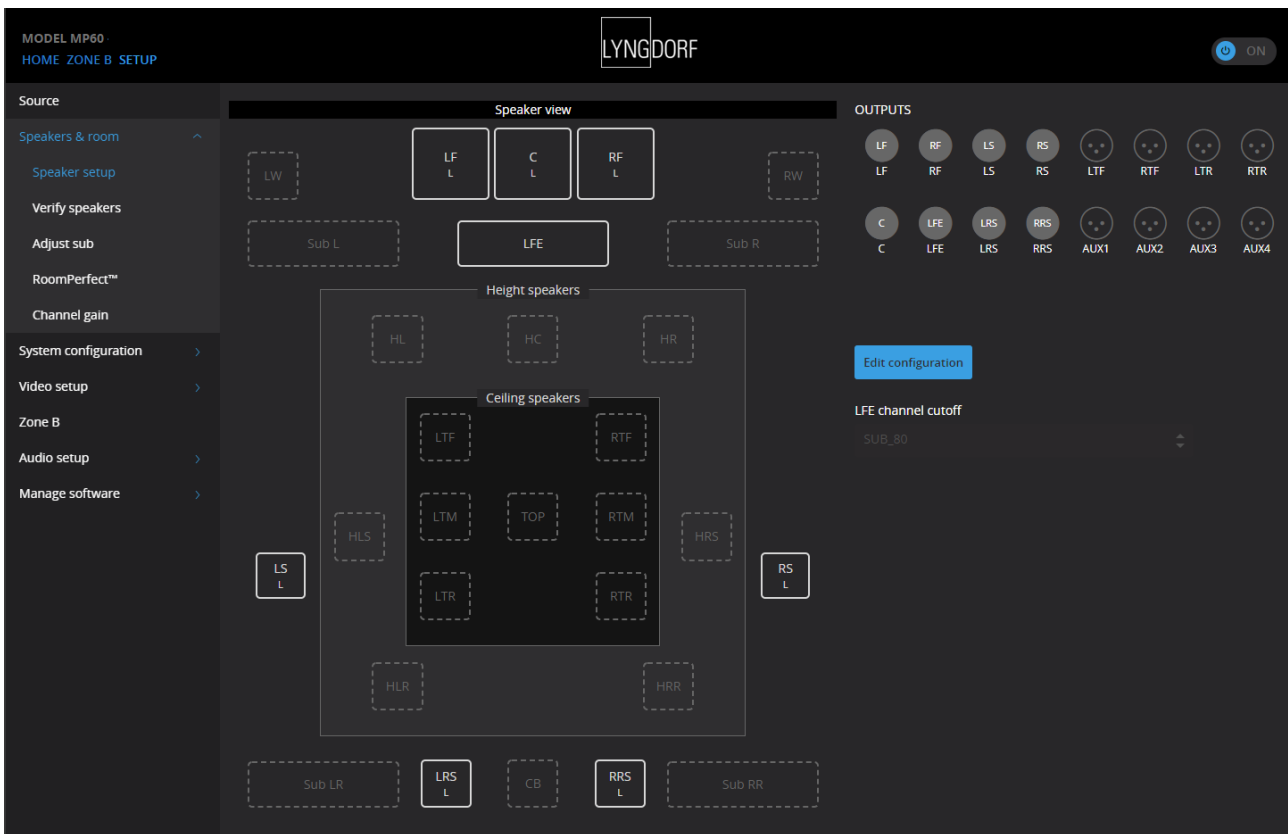

The setup page is an overview of the available speaker outputs.

In order to correct the setup, you press *EDIT CONFIGURATION*, and by selecting each speaker or subwoofer, you can specify size/bass cut-off and level.

Always **SAVE** the corrected setup before choosing another menu

Channel Designation

You should activate the speaker channels, which are in accordance with the DECODING FORMAT that you want to optimize – you should NOT focus on the actual position of the speaker. (ex.: the first surround speakers for a Dolby format are always LS and RS – also if they are positioned on the back wall). The available speaker positions are:

Designations	Channel Description
---------------------	----------------------------

Subwoofers:

LFE	Low Frequency Effects (Mono)
SUB L	Left Channel Subwoofer (Stereo / does not handle LFE, if LFE Subwoofer is activated)
SUB R	Right Channel Subwoofer (Stereo / does not handle LFE, if LFE Subwoofer is activated)
SUB RR	Right Rear Channel Subwoofer
SUB LR	Left Rear Channel Subwoofer

Low level speakers:

L	Left (Bi-amping available, if AUX outputs are available)
R	Right (Bi-amping available, if AUX outputs are available)
C	Center
LS	Left surround
RS	Right surround
LRS	Left rear surround (only available, if LS and RS are activated)
RRS	Right rear surround (only available, if LS and RS are activated)
CB	Center back

Speakers designated according to **Dolby ATMOS and DTS:X** specifications:

LW	Left wide
RW	Right wide
LTF	Left top front
RTF	Right top front
LTM	Left top middle (only available, if RTF and RTM are activated)
RTM	Right top middle
LTR	Left top rear
RTR	Right top rear

Speakers designated according to **AURO 3D** specifications:

HL	Height left
HR	Height right
HLS	Height left surround
HRS	Height right surround
HLR	Height left rear surround
HRR	Height right rear surround
HC	Height center
TOP	Top ceiling (aka: Voice of God)

Note:

A single (mono) subwoofer must be set as LFE subwoofer – no matter where you position it in the room

Sub Right and Sub Left is used in combination only, as it is used for a stereo setup – but you can activate both the LFE subwoofer and the Sub Right/Sub Left, which will direct the LFE signal to the dedicated subwoofer and direct the bass from the speaker channels to the Right and Left subwoofers.

LFE Channel cut-off

LFE (Low Frequencies Effects) is an individual audio channel for bass effects. The LFE channel cut-off will add a low-pass filter for the signal to this subwoofer. Apart from the standard settings you can create your custom cut-off setting.

The MP-60 can decode up to 16 channels (including the LFE, Low Frequencies Effects), and the system will inform you, if you try to activate more speakers than the MP-60 can process – or is trying to make a setup, which cannot be handled due to the limitations set by Dolby, DTS or Auro. An error message will appear!

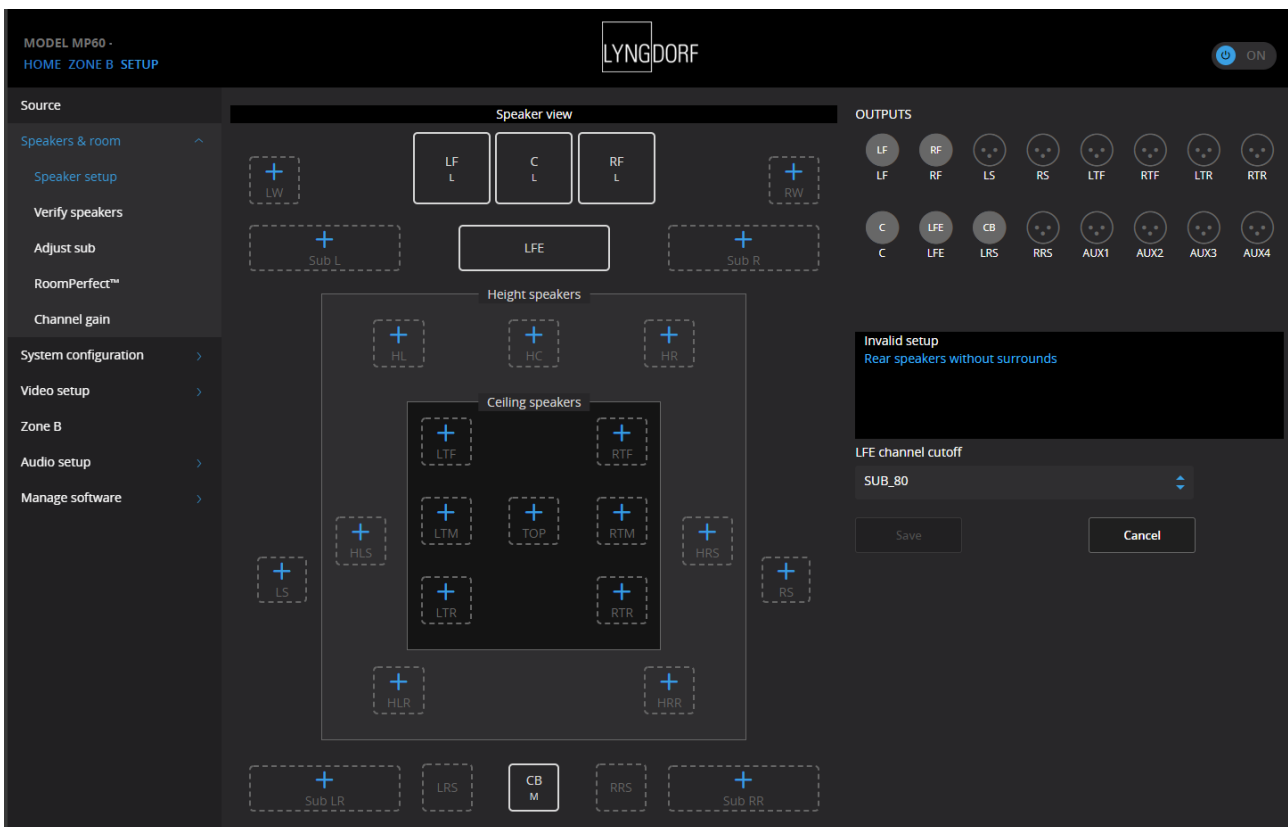

The errors could be:

Error trying to activate one or two rear surround speakers without any side surrounds. The initial surround sound speakers must be a pair of side surround speakers (LS & RS) – no matter where you position them.

Error trying to activate top or height speakers without the lower level speakers. If you only can position surround speakers in the ceiling, these must be designated as lower level surround speakers, as you are not creating a 3-dimensional sound field.

As a rule of thumb, don't make changes if you are not familiar with the consequences, and always make a backup before trying out other speaker setup options. When you change a size of speaker, LFE cut-off or any distance or delay settings, you need to do a new RoomPerfect calibration, as the interaction between room and speakers are changed.

Dialog boxes for speaker option

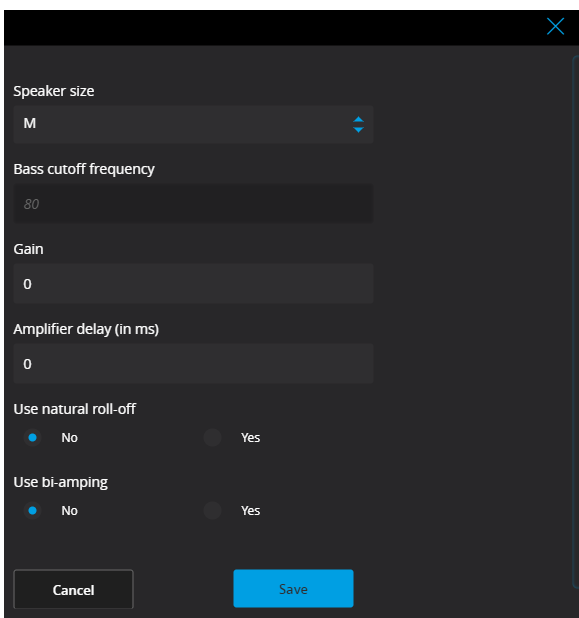

Speaker Size

When selecting a speaker size, you set the bass-cut-off frequency, and the signal information below this frequency will be sent to the subwoofer(s). By selecting CUSTOM, you can specify the cut-off frequency directly.

Gain

If a specific speaker channel is significantly lower in level compared to the other channels, you should decrease the gain on the highest channel to match the overall level of speaker output. (increasing gain on a speaker channel might cause a speaker or subwoofer to distort at levels below 0 dB). Even levels ensures, that the subsequent RoomPerfect™ calibration will run perfectly. (highest and lowest speaker levels are then within the microphones optimal calibration levels)

Amplifier Delay

In case you pass this speaker through an amplifier or subwoofer with internal processing, you need to compensate for this by entering the relevant delay in milli-seconds.

Note:

A simple D/A conversion will normally take around 0.5 ms, whereas a subwoofer with internal DSP processing (room correction) could delay the signal by 2 ms or more. The delay is the same, if the DSP filters are activated or not. We recommend that you do not activate room correction software in the subwoofer, as this will stress the amplifier and driver of subwoofer.

Use Natural Roll-Off

By activating the Natural Roll-Off the speaker signal will not be affected by the Bass Cut-Off settings – but a copy of the bass signal will be directed to the subwoofer(s). This is particularly relevant, if the frequency limitation of the speaker is close to the Bass Cut-Off frequency.

Use Bi-Amping

This setting is available for the Left and Right front speakers only (LF and RF). This will copy the signal to these speakers to a pair free outputs (if available), why you can use two amplifier channels to power each of these speakers.

Dolby Enabled Speakers

This function refers to a setup, where the front, side or side speakers are with an up-firing speaker to imitate a ceiling mounted speaker. Delay and gain can be set for these specific speaker channels. **Dedicated speakers for this purpose will feature a cue filter to improve the sensation that this sound is coming from the ceiling.**

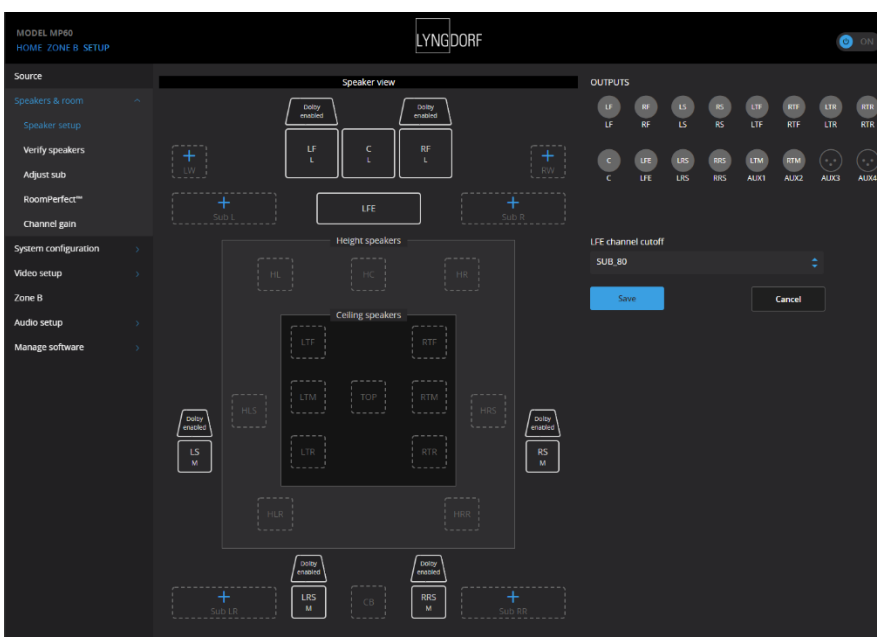

Subwoofer options:

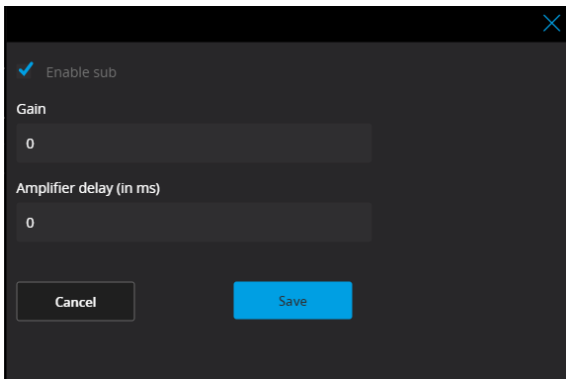

Enable or disable this subwoofer by using your mouse.

Gain

In a later process you will be guided through the level settings on your subwoofer. If the settings on the subwoofer does not allow for full correction, you can increase the level here to match the input sensitivity of your subwoofer.

Amplifier Delay

If your subwoofer features internal processing, you need to compensate for this by entering the relevant delay in milli-seconds (ms).

Verify Speakers

This function will allow you to test if the amplifiers and speakers are connected correctly to the outputs of the MP-60. Follow the directions on the screen.

Adjust Sub

As the subwoofers are handling the bass information from multiple speaker channels, it is essential that the subwoofer(s) are aligned with each other and with the relevant speaker channels. Without alignment you risk having an inferior performance due to stress on the subwoofer's internal amplifier.

With one or more active subwoofer(s) connected to the MP-60, this menu will guide you into setting the volume level on each subwoofer's controls. Follow the instructions on the display to go through two phases:

1. Find the correct **system volume** to do the Subwoofer adjustment (tones through speakers)
2. Adjust the volume setting **on each subwoofer** for the RoomPerfect™ calibration.

Channel Gain

This menu will allow you as per your personal preferences to change the level of each speaker, in its relations to the decoded signal. This means that if you prefer that some surround speakers are higher in level with DOLBY decoded material only, you can adjust this without affecting the level of the speaker, when

decoding DTS or Auro encoded materials. If you activate Show RP Level, you will see, how the RoomPerfect™ calibration has corrected each speaker channel.

RoomPerfect™

RoomPerfect™ is designed to analyze and correct for the negative effects that the listening room has on the speaker sound. See our website www.lyngdorf.com for more detailed information.

Global filter

The global filter improves sound quality across the whole room. When you are moving around a room, the global filter gives the best result.

Focus position

The focus filter improves the sound quality at a specific listening position. This makes the focus filter the best solution for optimal sound quality at a single listening position.

It is possible to add multiple focus positions. This must be done after performing the initial RoomPerfect™ calibration.

How to Set Up RoomPerfect™

Initial setup

Be sure to select the unit of measure, then enter the distances to the speakers and woofers.

How to measure distances to speakers and woofers

The best results are obtained by using a laser-equipped measuring device. Before starting, place the RoomPerfect™ microphone at listening height in the main listening position. For each channel, measure the straight-line distance through the air from the tip of the RoomPerfect™ microphone to the center of the tweeter unit in the loudspeaker in question. Do not measure distances at floor level, as these measurements will not give acoustically accurate results.

When measuring distances to **in-room** woofers:

- If the woofer(s) is in the corner of the room, measure the distance to the corner of the room.
- If the woofer(s) is up against the wall, measure the distance from the listening position to the back edge of the woofer.
- If you have a stack of woofers taller than the listening position, measure the distance from the listening position to the back edge of the middle of the stack.

When measuring distances to **in-wall** woofers:

- If the stack of woofers is taller than the listening position, measure the distance from the listening position to the dust cap of the middle of the stack of woofers.
- If the woofers are lower than the listening position, measure the distance from the listening position to the top dust cap of the top woofer.

The RoomPerfect™ microphone is a very sensitive and finely calibrated device which must be treated with utmost care. If the microphone has been dropped on the floor, it may be damaged. If this is the case, obtain a new microphone from your Lyngdorf Audio representative before performing the system calibration.

RoomPerfect™ Preparations

- Place the RoomPerfect™ calibration microphone on the stand. Be sure to fasten the screws properly so the microphone does not move during a measurement.
- Plug the supplied microphone cable into the microphone.
- Connect the microphone cable to the microphone terminal on the rear panel of your processor

Each RoomPerfect™ microphone is calibrated within very small parameters and using a new microphone does not require adding any calibration file. The microphone does not work with traditional power supply, and it cannot be replaced by any other microphone design.

Placing the Microphone in the Focus Position

When you are prompted to place the microphone in the focus position, place the microphone, using the microphone stand, in your primary listening position. The height and the orientation of the microphone should correspond to your head's height and direction.

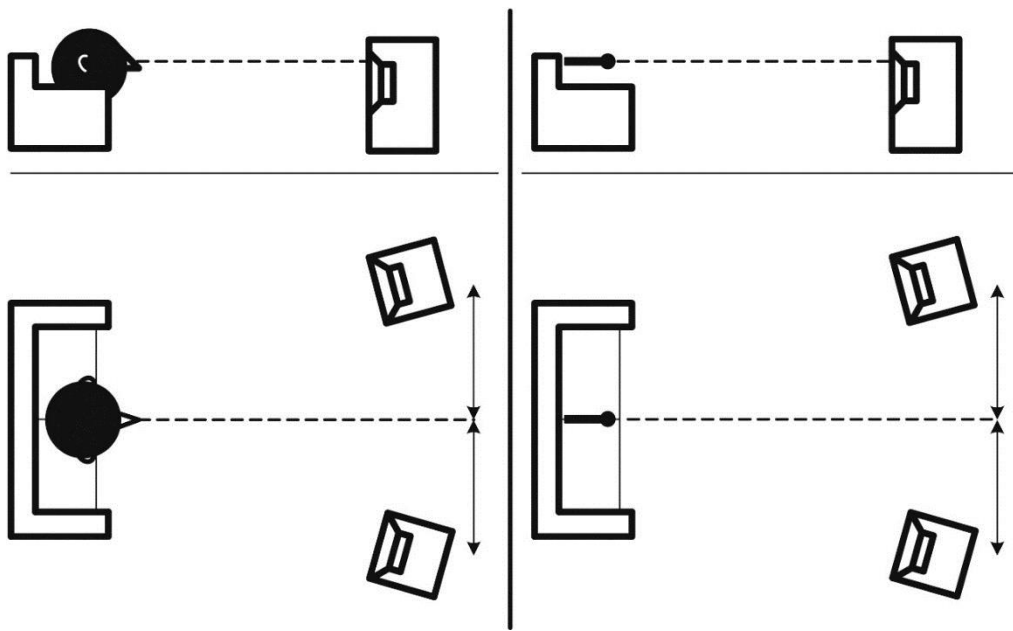

Volume Setting

Press Enter and a test signal will start from the left speaker. The system will give an estimated optimal volume for calibrating the system or will accept the current volume. Adjust the volume if required by the system and retry the measurement.

The calibration volume should not be so loud that it is inconvenient to you, or that it causes damage to your loudspeakers. If this is the case, set it to a lower and more appropriate level. A low volume can result in a longer calibration time or a measurement time-out. A low volume and long measurement will not affect the quality of the result.

Measuring the Focus Position

When the calibration volume has been set, RoomPerfect™ will send a range of tones to measure the focus position. If there is noise in the room, the measurement may take longer. This will not affect the quality of the result. See RoomPerfect™ troubleshooting if the measurement stops prematurely, and then retry the measurement.

Measuring Random Room Positions

When the focus position has been measured, the next step is to measure the acoustical properties of the room. It is important to perform well spaced measurements to get a comprehensive image of the acoustical properties of the room. See RoomPerfect™ troubleshooting if the measurement stops prematurely.

Keep taking measurements until RoomKnowledge reaches minimum 90%.

These are the rules of thumb when measuring the room:

- the microphone should be in random and varying positions, heights, and orientations. Point it up/down/sideways, the more random positions the better.

- the measurements should cover the entire room, not only your listening area.
- do not take measurements behind plants, furniture, etc.

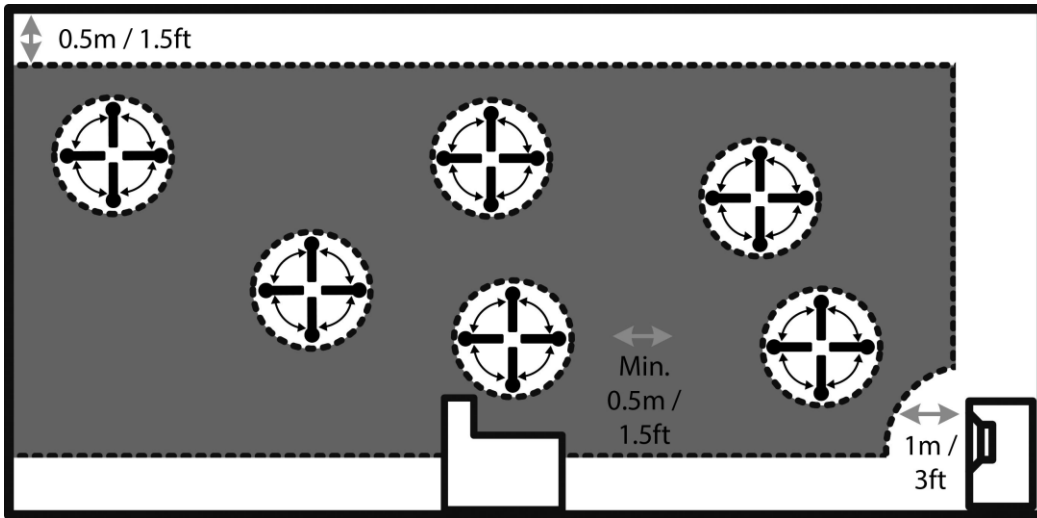

Side view of room

- the microphone should not be closer than 0.5m/1.5ft from the floor, ceiling, and walls.
- the microphone should be at least 1m/3ft from the front of the loudspeakers.
- there should be at least 50cm/1.5ft between each measurement.
- do not take symmetrical measurements in the room.

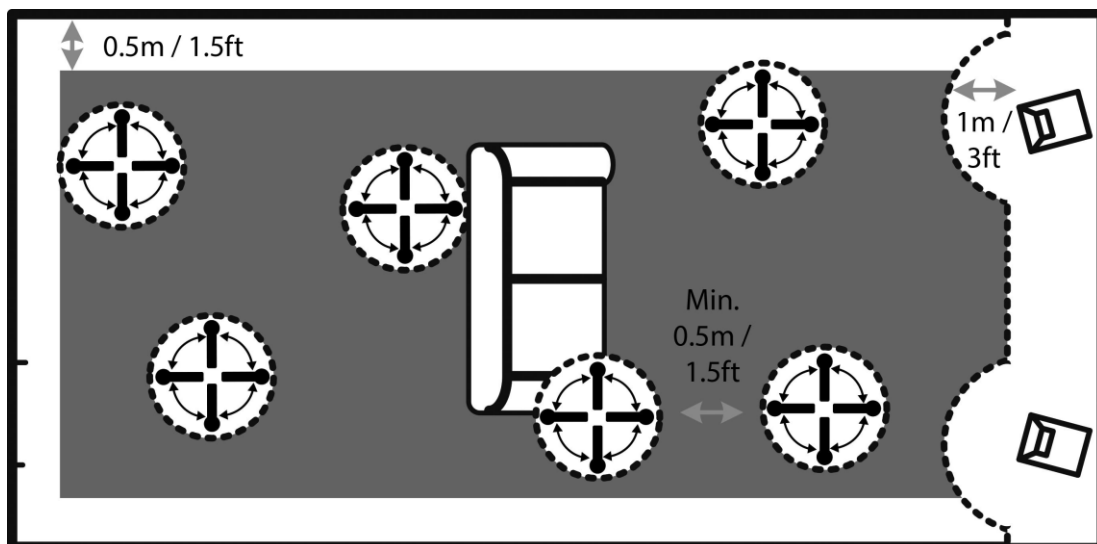

Top view of room

Room Measurements Above 90% RoomKnowledge

When RoomKnowledge has reached 90%, you can decide to add room measurements or do it later.

To fully optimize RoomPerfect™'s understanding of the room's acoustical properties, we recommend you keep doing measurements until the RoomKnowledge is above 95%. The higher the RoomKnowledge, the more accurate the room correction filters will be.

Calculation of Focus and Global Filters

When room measurements are complete, the system will calculate the focus and global filters automatically.

Note: We recommend that you ALWAYS make a backup of the MP-60 settings and calibration data after having performed a RoomPerfect™ calibration (see Manage Software in the Setup section).

System Configuration

General Setup

Power management

- Choose the standby mode
 - Deep sleep – The MP-60 can be turned on via remote control or the front on/off switch (Default)
 - Network Stand-By - The MP-60 can also be turned on via web interface, Remote App. or a RS232 based control system.
- Choose the delay before the processor automatically turns off, when no audio or video is processed. Setting it to 0 will disable the feature (always on).

Default volume settings

- Set a max volume for the device (dB). This setting is a safety precaution.
- Set startup volume
 - Use last volume – Sets the volume to be the same as when the MP-60 was turned off.
 - Use fixed volume – Sets the default volume at startup.

HDMI CEC settings

Set enable CEC and use ARC channel as audio input to Off or On.

Display timeout

Set seconds before turning off the display.

Password protection

Activate password protection for entering the setup menu from the remote control. The password is **7800**.

Show bypass

Allow for RoomPerfect™ to be set to bypass mode for demonstration purpose.

Enable front IR sensor

Turn the MP-60's IR sensor Off or On. This function is useful if you are using a home automation system and other remotes are using the same IR codes as the MP-60 remote.

Trigger Setup

Trigger In Setup

Allows you to set up the system so that the MP-60 can be switched on by an external device. The MP-60 will turn on if a voltage above 1.5V is detected.

Trigger Out Setup

Allows you to set up the system so that the MP-60 can control the power state of other devices like amplifiers and curtains through a simple connection.

Off – No action

Source – When the preset source for any zone is selected, it will trigger. Use source setup menu to associate the trigger with a source.

Source A – When the preset source for Zone A/Main zone is selected, it will trigger.

Source B - When the preset source for Zone B is selected, it will trigger.

Power A – When Zone A / Main Zone is On, it will trigger

Power B - When Zone B is On, it will trigger

Power any - When any Zone is On, it will trigger

You can set the trigger output to be on/off or as a pulse activation. You can select either a 5V or a 12V output. (settings menu appears, when a trigger system is activated on a source)

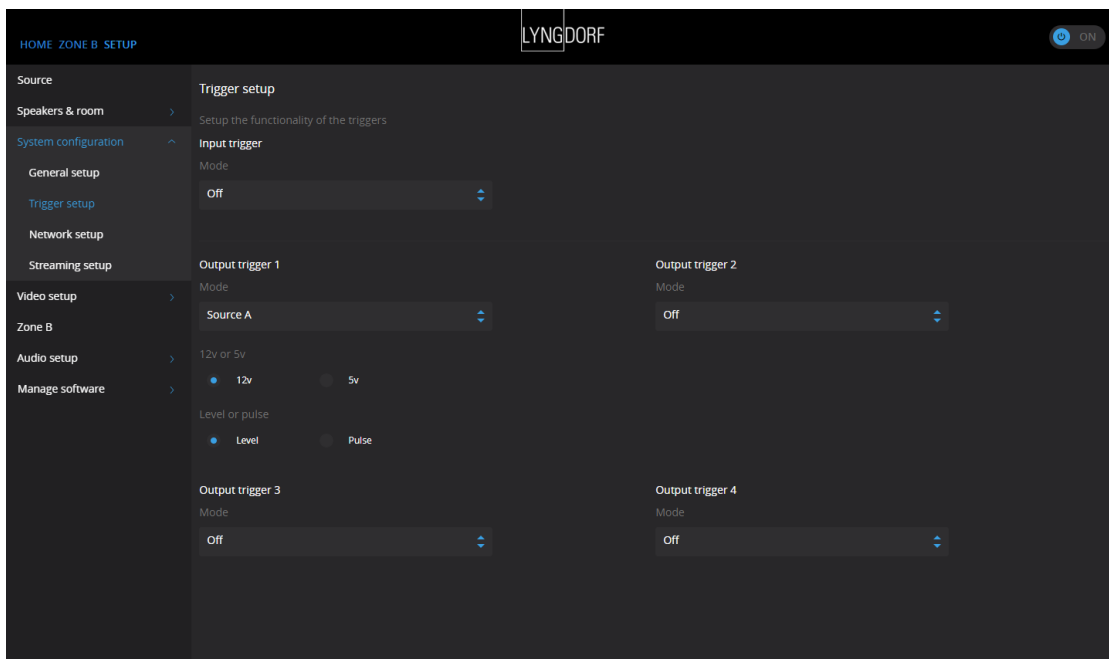

Network Setup

Connecting to MP-60 with a Network Cable

It is possible to get access to the MP-60's web interface via a direct cable connection between the MP-60 and a computer, or a connection via a hub or switch.

If you have a direct cable connection to a laptop (with no switch or router between the two) the network cable must be a crossover type. Furthermore, the Mode option in the Network Setup menu must be set to Manual IP. Finally, you must manually set an IP address on the computer you intend to use for setting up the MP-60.

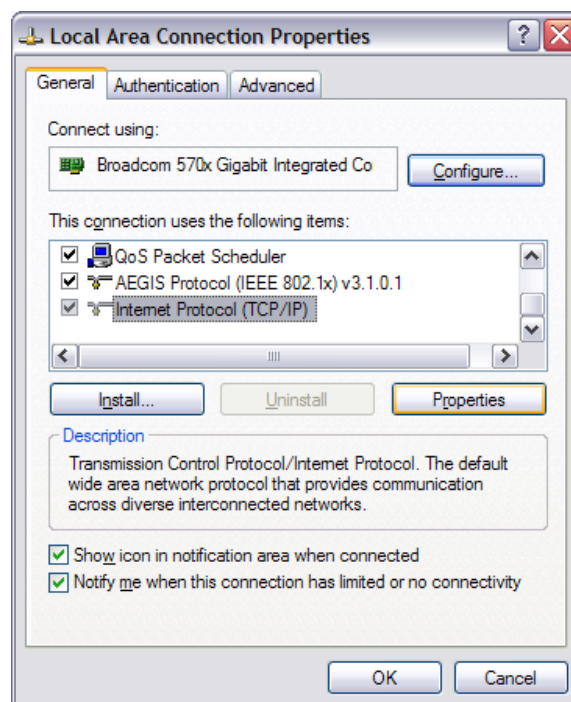

Set Up a Fixed IP Address in Windows 7

- Click Start / Control Panel / Network Connections to find the network connection that represents your connection to the Internet. Most often, this is labeled simply Local Area Connection.
- Right-click the connection and select Properties.
- Click Internet Protocol (TCP/IP) in the list (you may have to scroll down the list to find it)
- Click Properties.
- Most default configurations will have both Obtain an IP address and Obtain DNS server address automatically selected by default.
- Click Use the following IP address and enter the following:

IP address: 192.168.1.2
Subnet mask: 255.255.255.0
Default gateway: 192.168.1.1

Click OK to close the configuration windows, and you should now be able to access the MP-60 via your Internet browser.

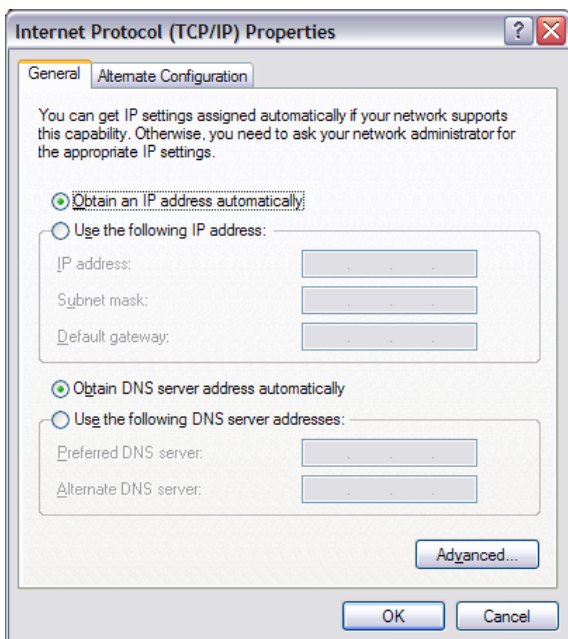

Set Up a Fixed IP Address in Windows Vista or Windows 10

- In Windows Vista, click Start / Control Panel / Select Network and Internet / Network and Sharing Center.
- In Windows 10, right-click Start, then select Control Panel. Select Network and Internet / Network and Sharing Center.
- Click Manage Network Connections in the list of tasks.
- Right-click your local area connection and click Properties.
- Select Internet Protocol (TCP/IP) from the list
- Click the Properties button.

Click Use the Following IP address and enter the following:

IP address: 192.168.1.2
Subnet mask: 255.255.255.0
Default gateway: 192.168.1.1

Click OK to close the configuration windows, and you should now be able to access the MP-60 via your Internet browser.

Streaming Setup

The MP-60 can access music files on your local network or on a FAT32 formatted storage device connected to any of the USB A inputs, and you can stream music to the MP-60 from your mobile devices.

In this menu you can configure the basic setup of the music streaming:

- Streaming players can control volume – set to Off or On
- Streaming players can change input source – set to Off or On
- Streaming players can power on the device from standby mode – set to Off or On

Streaming Playback

The setup of the streaming player itself is done in the interface positioned in the HOME section.

Airplay

When the MP-60 is connected to your local network, it will automatically be available from your Airplay enabled devices.

Spotify Connect

When the MP-60 is connected to your local network, it will automatically be available from your Spotify Connect enabled devices (requires a Spotify Premium account)

UPnP

This function allows you to select and play music files in UPnP enabled libraries on your local network. The button ‘..’ brings you up in the menu structure of your library. You might have problems in accessing files as UPnP a set of protocols and not a defined standard. The implementation of UPnP is therefore not always fully functional for media playback.

USB

This function allows you to select and play music files on attached USB devices (FAT32 format). The button ‘..’ brings you back up in the menu structure of your library. It opens when an USB device is detected in any of the inputs.

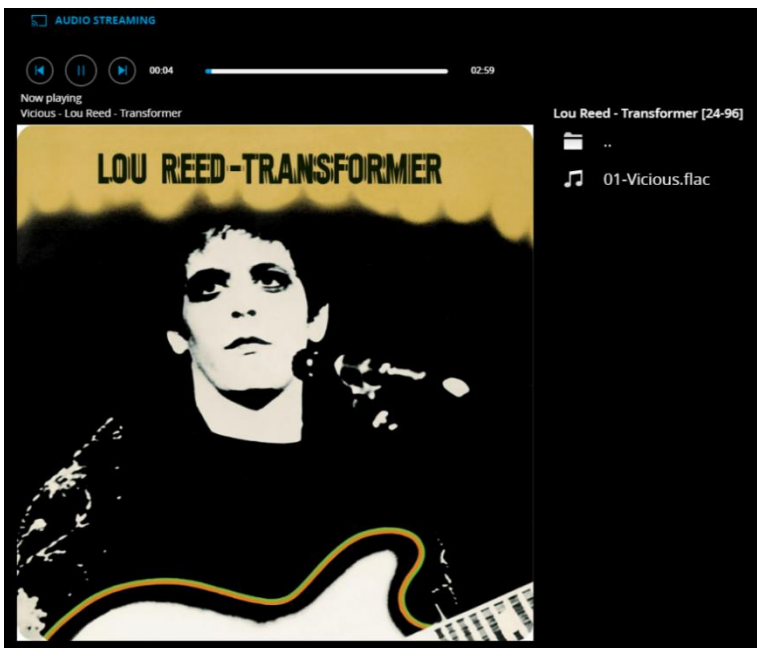

vTuner

This function allows you to access radio stations and podcasts around the world. You can search stations and podcasts through references to genre or geographical relation.

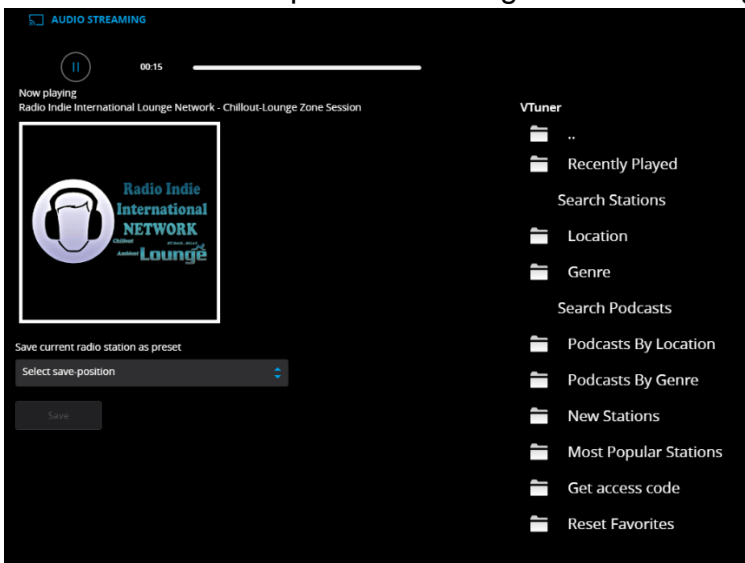

When a station or podcast is playing, you can assign it to one of the 4 'select save-position'. The saved stations can as presets be assigned to a SOURCE for direct selection, if you as 'audio input' select 'Internal Player' (see menu: SETUP/SOURCE).

Video Setup

The Video Setup menu allows you to register the video system settings for the MP-60's video inputs and outputs, which in turn dictates which video formats can be shown on the screen when these inputs and outputs are activated.

With a single TV/Projector these settings are set automatically.

*As a rule of thumb, don't make changes if you are not familiar with the consequences,
and always make a backup first!*

Video Output

This menu manages the default and preferred setting for all video outputs.

Set the main video output of your device

Here you select which of the HDMI output connectors or the HDBaseT output is to be your output for the main setup. Other outputs can be set to 'follow main' or be set individually to stream video from a specific HDMI input connector.

The MP-60 features eARC (Enhanced Audio Return Channel), which will allow the television to send a Dolby Atmos encoded audio track back through the HDMI cable coming from the MP-60. eARC will only function on the HDMI 1 output.

The MP-60 features an internal HDMI matrix, why it is possible to control all three outputs via a control system in order to select individual audio and video information to be distributed to other televisions.

Default Video source

Here you set the output to be 'independent' of other outputs, 'follow main' or fixed at a given HDMI input.

HDMI Audio out

Here you select 'Pass-through' to have an audio output related to the video input output or not. Alternatively, you can select the output for connecting audio through a HDMI cable to the Zone B.

Video Input

In this menu, you can change what is advertised to the sources on the HDMI inputs. This is essential, if you have more than one screen connected to the HDMI outputs. If the screens are not identical in terms of support to video features, one of the screens might go blank, as it cannot process the signal requested by the other television.

EDID (Extended Display Identification Data) is an embedded data file sent from the television(s) through the MP-60 to the sources. This communication of data differs from the communication between television and a source connected directly to the screen, why you cannot test the function of the MP-60 through connecting sources directly to the television. The television is the Master of this communication and is informing all sources of what signal types, it can receive. The MP-60 is a HDMI Repeater, and will correct the EDID information sent to the sources, if you have changed any of the settings.

Video Settings

For each of the video features you can specify, when this feature is included in the EDID request to sources:

- Never /Feature is not requested
- Always /Feature is always requested
- One /Feature is requested, if one of the screens accepts it
- All /Feature is requested, if all connected screens accepts it

The features controlled are:

- Basic 3D /3D video
- HDR /High Dynamic Range (Static type, ex.: HDR+, HDR10)
- Dolby Vision /High Dynamic Range (Dynamic type)
- Deep Color /Bit depth for improved color reproduction
- HLG /High Dynamic Range for streaming (Hybrid Log Gamma)
- HDMI 2.0 /Communication protocol (alternatively: HDMI 1.4)

Audio

Depending on the type of source you can specify, what is the optimal audio track:

- PCM or Bitstream, multichannel (can be sent in stereo to Zone B only if played in main Zone)
- PCM only, multichannel
- PCM stereo only
- PCM stereo up to 48 kHz only

HDMI Bandwidth

If the HDMI signal chain cannot support the full resolution due to cable length or connected components, you can limit the maximum bandwidth to 300 MHz or 150 MHz to avoid dropouts.

Zone B Setup

Zone B refers to an adjacent space, which is linked to the main setup. An example could be a bar area outside the listening area, where you want to play the stereo soundtrack of the cinema or select any of the other sources connected to the MP-60. In this menu you can adjust the default settings.

The Zone B audio output can be controlled by a control system, the web interface or the remote application – not the handheld remote. This output can output a digital, stereo audio signal, which you can use as input for a system in adjacent rooms. The MP-60 can decode one HDMI source only and selecting 'Follow Main' will output a stereo downmix of the movie in the main room. The output does not hold any RoomPerfect™ filters.

Audio Setup

Audio Processing

This menu allows you to manage the audio processing presets for DTS, AURO and Dolby. These settings are required by DTS, AURO and Dolby and cannot be managed by us.

Dynamic Range Control functions in general with raising the level of quiet sounds and lowering the level of the loud sounds. This is also known as Night Mode, but it works differently in the various formats, why you can set it up for each format.

Dolby Center Spread is dedicated Dolby function to spread (copy) the center channel dialogue into the left and right speakers to fit a very large screen.

Auro Strength sets the amount of generated signal to other channels in the postprocessing / up-mixing. Auro Presets lets you select a channel configuration that best suits your speaker setup.

Voicing Setup

A voicing is an equalizer filter that can be activated to amplify or attenuate certain frequencies according to your personal preferences. This equalization is an addition to the RoomPerfect™ corrections. Voicings can be edited, deleted, added, or loaded in the MP-60.

Editing and adding voicings

In the web interface, you can edit or add a voicing by combining up to eight filter sections. For each section, you can choose between parametric or high and low shelves as well as high and low-pass filters. Once the filter type is selected, you can insert a center frequency, Q, and gain. Then the filter, including the final voicing, is shown as a graph so that you can immediately see the result.

We recommend you create voicings using the web interface, but they can be created using the remote

control. You can download all your voicings as a file to a USB stick – and these can then be uploaded to replace all voicings in another Lyngdorf multichannel processor.

Manage Software

From this main menu, you can access MP-60 software information, backup, restore, etc.

Download system log

Here you can download a syslog file to your PC/MAC – this file will hold information as to the decoder and software behavior. In case of a problem occurring, this file should be included in the correspondence for the factory for check.

Backup

Make a complete system backup, including speaker setup and RoomPerfect™ measurements. You can back up to an USB pen-drive or the SD card, if inserted. You can name the backup for easy identification, if you want to be able to return to this setup after testing another setup of speakers. This file can also be used to move the entire setup to another MP-60 processor – and it can be included in communications as to setup issues. When the backup is complete, the MP-60 will go into standby mode.

Restore

Restore the system from a backup file. Select the backup file and start the process. When the restoring is complete, the MP-60 will go into standby mode.

Factory Reset

Restore the system to the default factory settings.

Note: All user preference settings, system data, and RoomPerfect™ data are lost when the MP-60 is restored to the default settings, so make a backup if you want the option of restoring to the present setup.

Update Software

Update from Remote Files

When connected to the Internet, the MP-60 will automatically identify new software updates from our server.

1. Select the file listed on the remote server list.
2. Press Start Update to upload the new software to the MP-60.

Update from Local Files

On the product page of www.lyngdorf.com you will be available to download the software file for an update of the processor.

Via web interface:

3. Click Browse to find a file stored on your computer.
4. Press Start Update to upload the new software to the MP-60.

Or:

1. Upload the software file to a FAT32 formatted USB pen drive.
2. Make sure you 'eject' the pen drive correctly before removing it from your PC/MAC
3. Insert the pen drive into the USB A connector on the MP-60.
4. Browse and select the file in the menu and click Start Update

Note: System settings and RoomPerfect™ data remain intact during software updates.

Troubleshooting

RoomPerfect™

The calibration microphone is very sensitive and may pick up unwanted noise, including subsonic signals and background noise, which disturbs the measurements. If the signal is disturbed, it will take longer for the system to make a correct measurement.

A measurement that has been disturbed by noise but completed will always be correct; it is not necessary to redo it. If the measurement has stopped due to an error, one of the error messages below will be shown.

Error Messages

No microphone connected

No microphone or cable is registered, why the microphone connection is not working. Check that the microphone cable is connected to the microphone socket on the back panel. If the problem continues, test the microphone cable by connecting the microphone directly into the microphone socket and select Retry.

If the microphone is detected, replace the microphone cable and retry the measurement.

Fault – No signal

This error message can arise due to a signal classification of no sound. This happens if the sound volume has been muted or a cable is disconnected.

- Check the sound volume.
- Check all cable connections, including interconnects, speakers, amplifiers, etc.
- Check the measuring signal volume.

If none of these measures solve the error, request a replacement microphone from Lyngdorf Audio.

Fault – Signal clipping

Either the incoming signal has been classified as too loud, resulting in clipping or distortion, or a loud noise in the immediate environment has corrupted the measurement results. If a loud noise has in fact occurred, such as the sound of a closing door, reduce noise levels inside and in the immediate vicinity of the room and repeat the measurement. If no loud noise has occurred, reduce the volume of the signal and repeat the measurement.

Fault – Low signal

This error message is displayed when the measurement has lasted more than 5 minutes for the low-frequency signal or more than 2 minutes for the high-frequency signal. This happens most often when using a low-level measuring signal compared to the background noise in the listening environment, which results in prolonged measuring times. Raise the measuring signal volume or reduce the noise in the environment before continuing with the measurement.

If raising the volume does not eliminate the error message, the microphone or cable might be defective. Test the microphone cable by connecting the microphone directly into the microphone socket and select Retry.

Can't Turn On Via LAN or Control System

- The MP-60 needs to be set to Network mode to be able to turn on via a control system. It will not turn on when in Deep Sleep. This is set up in System Configuration / General Setup/ Power Management

Retrieving and Sending an Error Log

The processor generates a log file, which contains information of all detections and actions made by the software. To retrieve an error log holding, you need to access the MP-60 via your browser. Under 'Manage Software' you can download a text file and email it to your Lyngdorf Audio representative.

3D Compatibility Not Detected

If the MP-60 isn't fully booted, a Blu-ray player will not be able to detect its 3D compatibility. Restart the player to fix the problem.

Remote Control Doesn't Work

The remote control is paired to the MP-60 at the factory; you need to pair it again only if you have a new MP-60 or remote. To pair the RF remote control to a MP-60:

1. Turn on the MP-60.
2. On the remote hold down Play and OK until the remote control's green LED flashes.
3. Point the remote control at the MP-60 and hold it within 30cm / 1 foot of the front panel; when the green LED stops blinking, the remote is connected via Zigbee.
4. The remote will be paired to the MP-60.

To switch the remote from RF to IR mode, hold down OK and 1. The LED will flash red twice.

To switch the remote back to RF mode, hold down OK and 2. The LED will flash green twice.

To reset the pairing of the remote control, press Back and OK until the red LED flashes twice.

Trademarks

For DTS patents, see <http://patents.dts.com>. Manufactured under license from DTS Licensing Limited. DTS, the Symbol, & DTS and the Symbol together are registered trademarks, and DTS:X and the DTSX logo are trademarks of DTS, Inc. © DTS, Inc. All Rights Reserved.

HDMI, the HDMI Logo and High-Definition Multimedia Interface are trademarks or registered trademarks of HDMI Licensing LLC.

Dolby and the double-D symbol are registered trademarks of Dolby Laboratories.

This product incorporates technology that is protected by U.S. patents and other intellectual property rights. Use of this technology must be authorized by Macrovision, and is intended for home and other limited viewing uses only, unless otherwise authorized by Macrovision. Reverse engineering or disassembly is prohibited.

This item incorporates copy protection technology that is protected by U.S. patents and other intellectual property rights of Rovi Corporation. Reverse engineering and disassembly are prohibited.

HDBaseT™ and the HDBaseT Alliance logo are trademarks of the HDBaseT Alliance.

Service Information

In order to obtain warranty service, you must contact your original dealer or alternatively the Lyngdorf Audio distributor of the region or country where you are located.

